

MERITSUN[®]

15KWH Powerwall Battery Pack User Manual





Please comply with all warnings and operating instructions in this manual strictly. Save this manual properly and read carefully the following instructions before installing the unit. Do not operate this unit before reading through all safety information and operating instructions carefully.

1.SAFETY PRECAUTION	3
1.1 WHEN USING BATTERY	3
1.2 WHILE CHARGING	4
1.3 WHEN DISCHARGING THE BATTERY	4
2.PARAMETERS OF BATTERY	5
2.1 BASIC BLOCK DIAGRAM	5
2.2 BATTERY SPECIFICATIONS	6
2.3 PANEL VIEW	7
2.4 LED INDICATORS	8
2.5 BUZZER OPERATION (OPTIONAL)	9
2.6 DISPLAY FUNCTION INSTRUCTION	10
2.6.1 Display rendering	10
2.6.2 Functional Specifications	10
2.7 CONNECTORS	13
2.8 WAKE UP BUTTON	13
3. SAFE HANDLING GUIDE	13
3.1 SYSTEM DIAGRAM	13
3.2 TOOLS	14
3.3 SAFETY GEAR	14
3.4 INSTALLATION	14
3.4.1 Inventory of items	14
3.4.2 Installation Location	15
3.4.3 Wall-mounted	15
4. OPERATING INTRUCTIONS	16
4.1 SOFTWARE INSTALLATION	16
4.2 PRE-OPERATION STEP	16
4.3 COMMUNICATION FUNCTION	17
4.3.1 Communication port definition	17
4.3.2 Battery communicate with PC/Software	18
4.3.3 Batteries communicated with inverter	19
5. TROUBLESHOOTING	21
6. STORAGE AND MAINTENANCE	22
6.1. STORAGE	22
6.2. MAINTENANCE	22
7 PRODUCT RESPONSIBILITIES AND CONSULTING	23

1.Safety Precaution

1.1 When Using battery

Danger of High Voltage:

The high voltage power supply offer the equipment power, wet object contact high voltage power supply directly or indirectly , can cause fatal danger.

Using a special tool :

Working in high voltage and ac power, be sure to use a special tool instead of individual tools.

Static-free:

Static electricity would damage veneer on the electrostatic sensitive components, before touching the plug-in, circuit board or chips, be sure to use correct electrostatic prevention measures.

Disconnect the power supply in operation:

When operate the power supply, you must first cut off power supply, power operation is prohibited.

Dc short circuit dangerous:

Power system provides dc regulated power supply. Dc short circuit could cause fatal damage to the equipment.

1.2 While Charging

 **CAUTION**

The temperature range over which the battery can be charged is 0°C to 45°C. Charging the battery at temperatures outside of this range may cause the battery to become hot or to break. Charging the battery outside of this temperature range may also harm the performance of the battery or reduce the battery's life expectancy.

1.3 When Discharging the Battery

 **DANGER**

Do not discharge the battery using any device except for the specified device. When the battery is used in devices aside from the specified device it may damage the performance of the battery or reduce its life expectancy, and if the device causes an abnormal current to flow, it may cause the battery to become hot and cause serious injury.

 **CAUTION**

The temperature range over which the battery can be discharged is -20°C to 60°C. Use of the battery outside of this temperature range may damage the performance of the battery or may reduce its life expectancy.

2.Parameters of Battery

2.1 Basic Block Diagram

- There are Battery cells and BMS board inside, before connecting the terminal, please read the diagram, and make sure the output is no short or other abnormal connection.

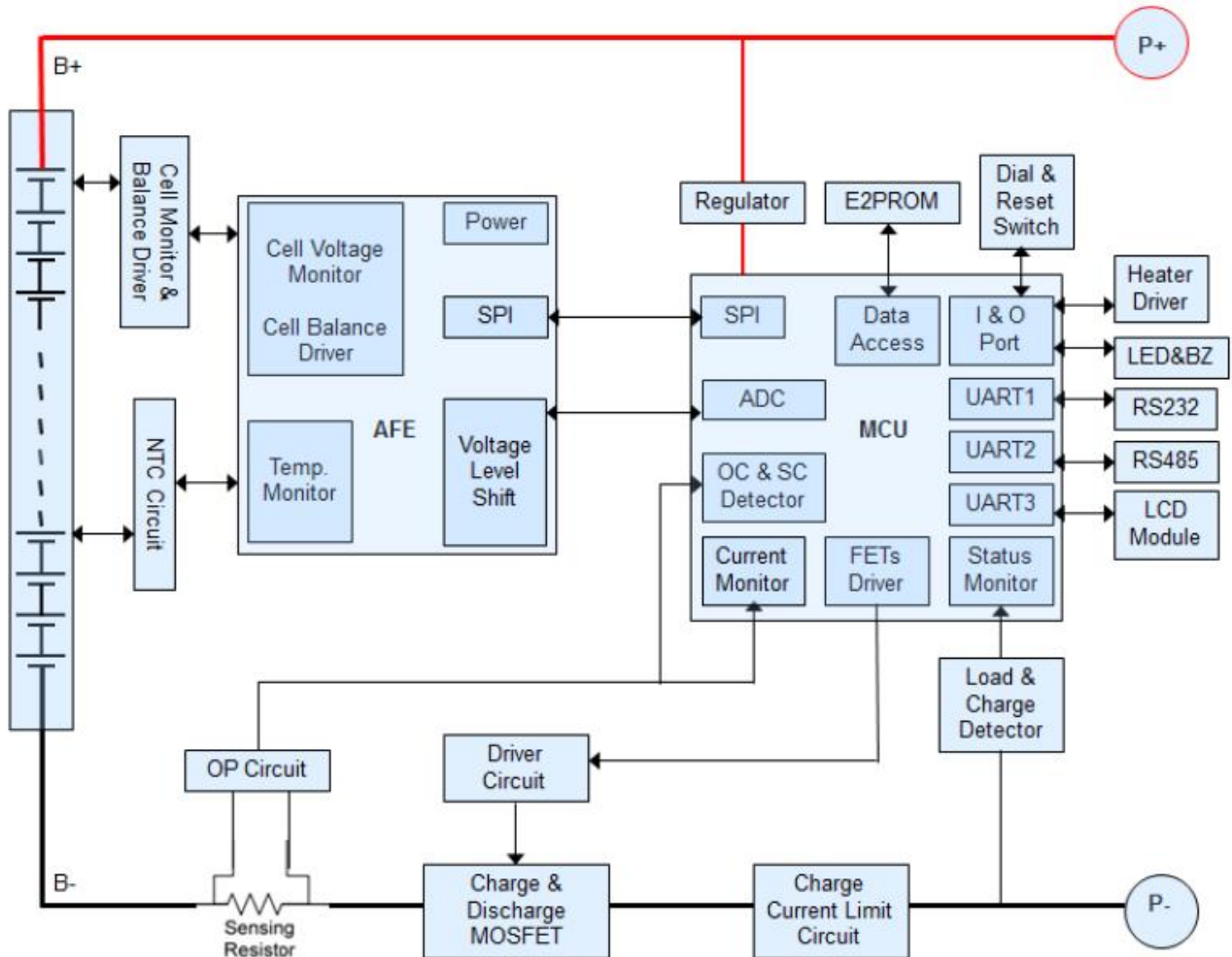

Fig1 Battery Block Diagram

2.2 Battery Specifications

Battery Specifications	
Model NO.	LFP300-48
Nominal Parameters	
Voltage	48V
Capacity	300Ah
Energy	14.4KWh
Dimensions(L*W*H)	600*1100*230mm
Weight	158Kg
Basic Parameters	
Design life time(25°C)	20 years
Life cycles(80% DOD,25°C)	8000 Cycles
Storage tiome/temperature	5 moths @ 25°C;3 moths @ 35°C;1 moths @ 45°C
Operation temperature	-20°C to 60°C @ 60±25 Relative Humidity
Storage temperature	0°C to 45°C @ 60±25 Relative Humidity
Lithium battery standard	IEC62619,UN38.3,ROHS,CE-EMC,UL 1642,MSDS
Enclosure protection rating	IP30
Electrical Parameters	
Operation voltage	48Vdc
Max. charging voltage	54Vdc
Cut-off discharge voltage	40.5Vdc
Max. charge and discharging current	150A

Battery Specifications	
Model NO.	LFP300-51.2
Nominal Parameters	
Voltage	51.2V
Capacity	300Ah
Energy	15.36KWh
Dimensions(L*W*H)	600*1100*230mm
Weight	165Kg
Basic Parameters	
Design life time(25°C)	20 years
Life cycles(80% DOD,25°C)	8000 Cycles
Storage tiome/temperature	5 moths @ 25°C;3 moths @ 35°C;1 moths @ 45°C
Operation temperature	-20°C to 60°C @ 60±25 Relative Humidity
Storage temperature	0°C to 45°C @ 60±25 Relative Humidity
Lithium battery standard	IEC62619,UN38.3,ROHS,CE-EMC,UL 1642,MSDS

Enclosure protection rating	IP30
Electrical Parameters	
Operation voltage	51.2Vdc
Max. charging voltage	57.6Vdc
Cut-off discharge voltage	43.2Vdc
Max. charge and discharging current	150A

2.3 Panel View

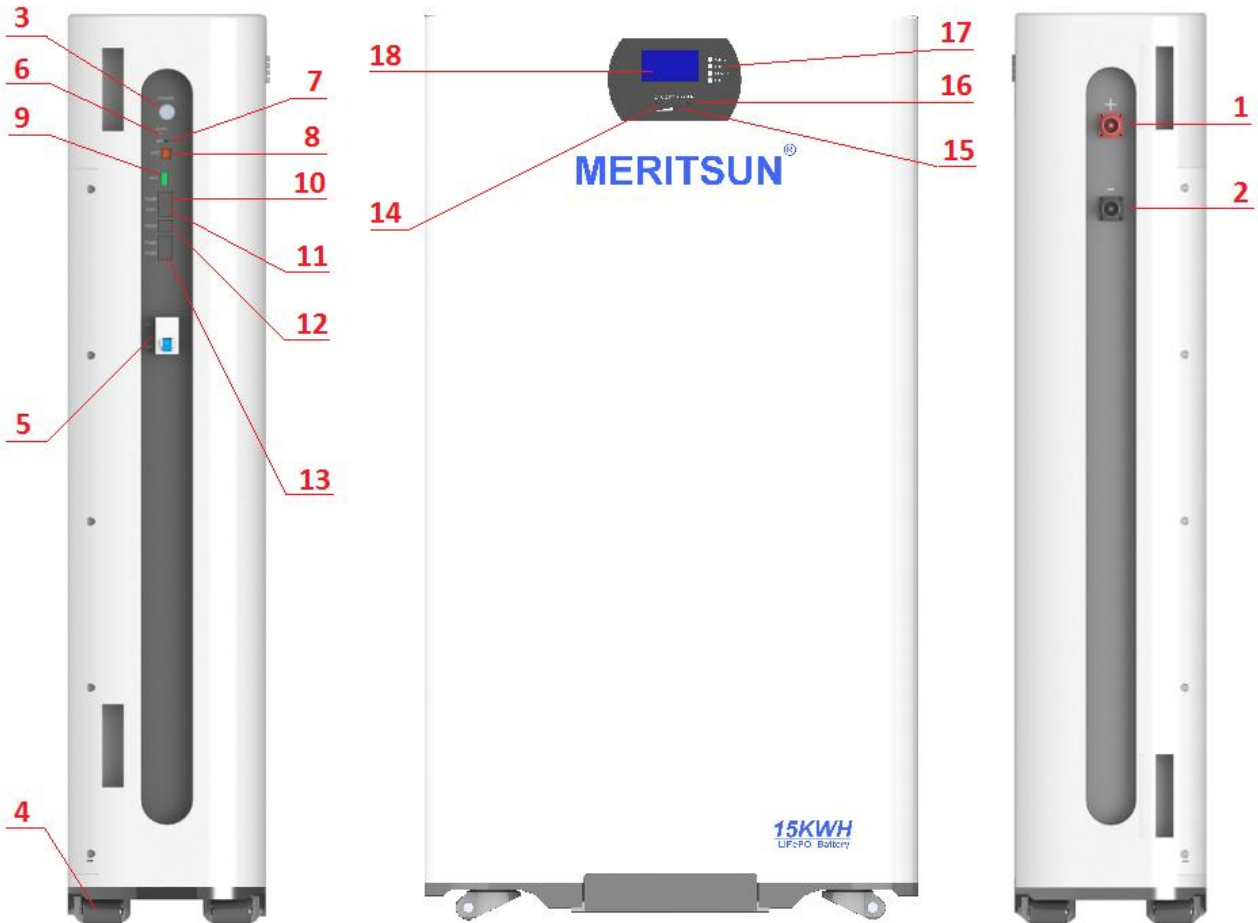

No.	Description	Functional Description
1	Battery +	Positive terminal
2	Battery -	Negative terminal
3	Metal Button	Battery ON/OFF Button

4	Wheel	/
5	MCB	Output ON/OFF
6	ON/OFF LED	Battery ON/OFF Indicator LED
7	RST Key	Reset Button
8	Display Connection Address	ADS Dialer
9	DCT	2 Road Dry Contacts
10	RS485 Communication Port	RS485 Communication Interface
11	CAN Communication Port	CAN Communication Interface
12	RS232 Communication Port	RS232 Communication Interface
13	RS485 Communication Port	2 Road RS485 Ports For Battery Communication In Parallel
14	Capacity LED	Electricity Volume Indicator
15	ALM LED	Alarm Indicator Light Blinking
16	Run LED	Run Indicator Light
17	LCD Key	LCD Operated Button
18	LCD	Display Screen

2.4 LED Indicators

LED Indicators:

There are 6 LEDs on upper panel to show the battery working status:

Pack Status	Normal/Alarm/Protection	RUN	ALM	SOC Indication LED				Remark
		●	●	●	●	●	●	
Power Off	Sleep	OFF	OFF	OFF	OFF	OFF	OFF	All OFF
Standby	Normal	Flash 1	OFF	Indication by SOC				Standby
	Alarm	Flash 1	Flash 3					Battery undervoltage
Charge	Normal	ON	OFF	Indication by SOC				-
	Alarm	ON	Flash 3					-
	Over Charge Protection	ON	OFF					-ALM LED is off when overcharge protection
	Temperature/	OFF	ON					Stop charge

	Overcurrent protection							
Discharge	Normal	Flash 3	OFF	Indication by SOC				-
	Alarm	Flash 3	Flash 3					-
	Over Discharge Protection	OFF	OFF					Stop discharge
	Temperature/ Over current /Short circuit protection	OFF	ON					Stop discharge
Fault		OFF	ON	OFF	OFF	OFF	OFF	Stop charge & discharge

NOTE: LED function can be set by monitor software, the default is on.

Flash	ON	OFF
Flash1	0.25Sec	3.75Sec
Flash2	0.5Sec	0.5Sec
Flash3	0.5Sec	1.5Sec

2.5 Buzzer Operation (Optional)

Model	Description and Status
Fault	Buzzing 0.25S per 1Sec
Protection	Buzzing 0.25S per 2Sec (expect for over-charge protection)
Alarm	Buzzing 0.25S per 3Sec (expect for over-charge alarm)

NOTE: Buzzer function can be set by monitor software, the default is off.

NOTed: Circuit breaker of battery circuit is set to OFF, connect it to switch power supply, and output voltage of switch power supply is set to (48V) 52.5-54V/(51.2V)56-57.6V, current set to 0.2C; after all settings done, switch the circuit breaker ON

2.6 Display function instruction

2.6.1 Display rendering

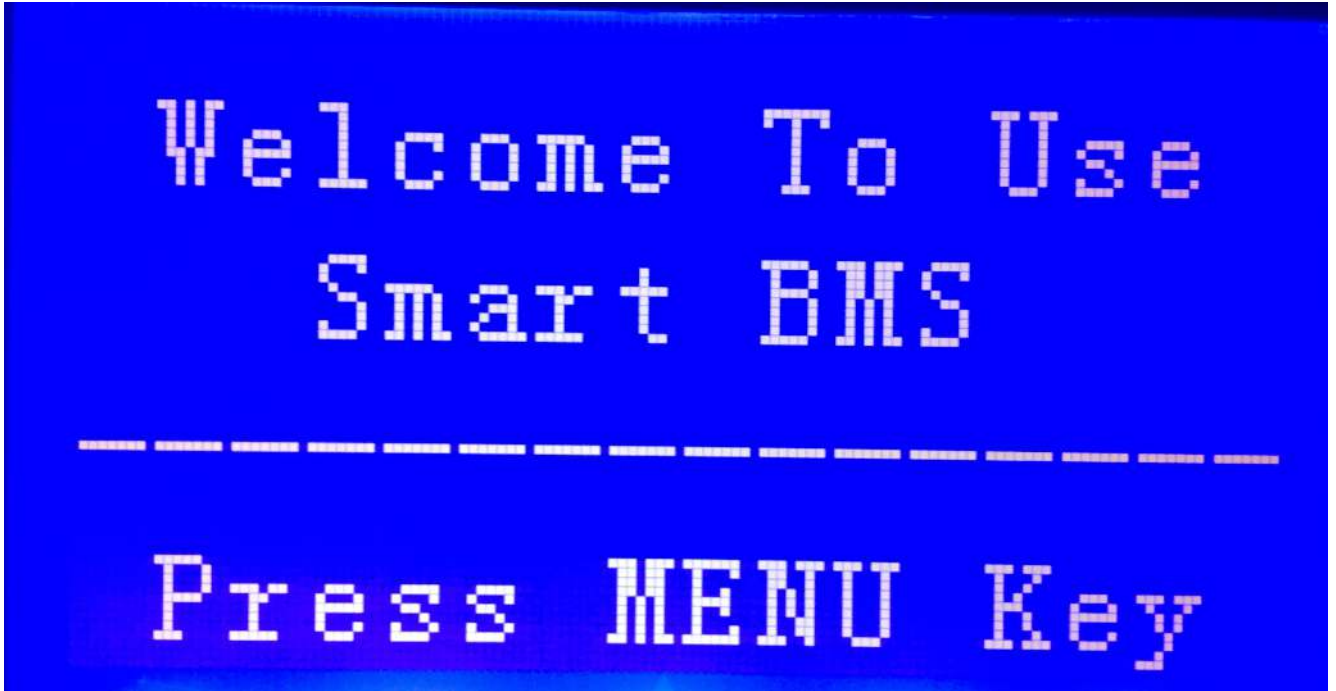

2.6.2 Functional Specifications

2.6.2.1 Main menu page

Electricity / dormancy activated, will show the welcome screen, press the MENU button to enter the main menu page. As shown in the figure below:

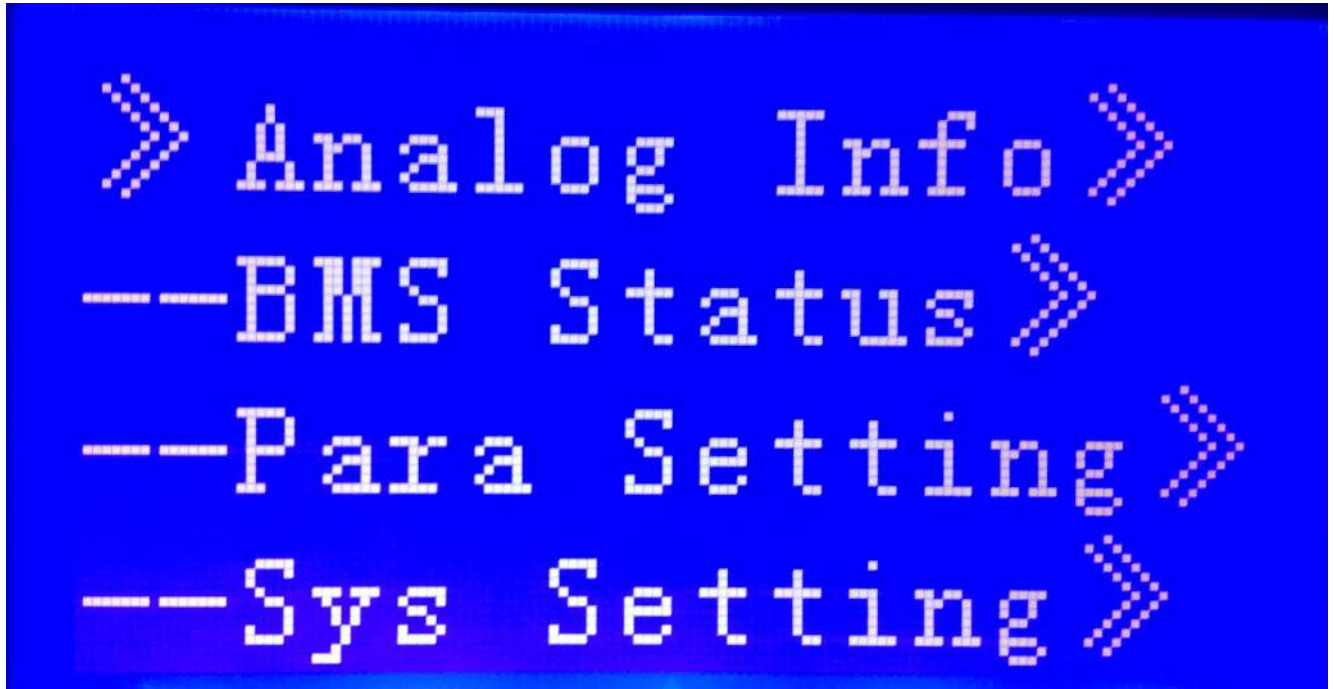

2.6.2.2 Battery parameters collection page

When the cursor “>>” is point to “Analog Info” , press ENTER key will enter into the page of “Analog Info” , As shown in the figure below:

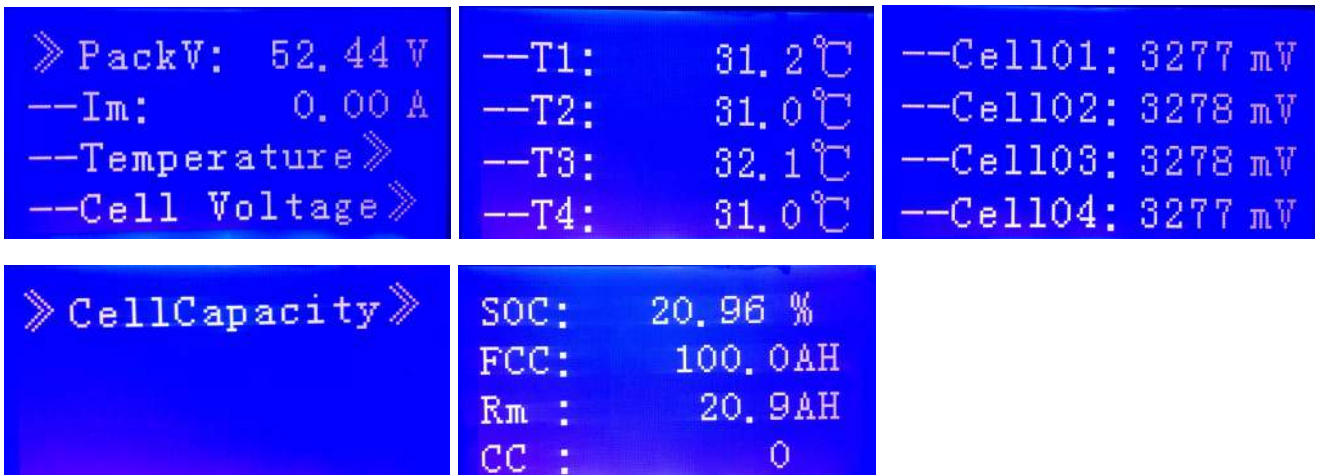

2.6.2.3 Battery status page

When the cursor “>>” is point to “BMS Status” , press ENTER key will enter into the page of “BMS Status” , As shown in the figure below:

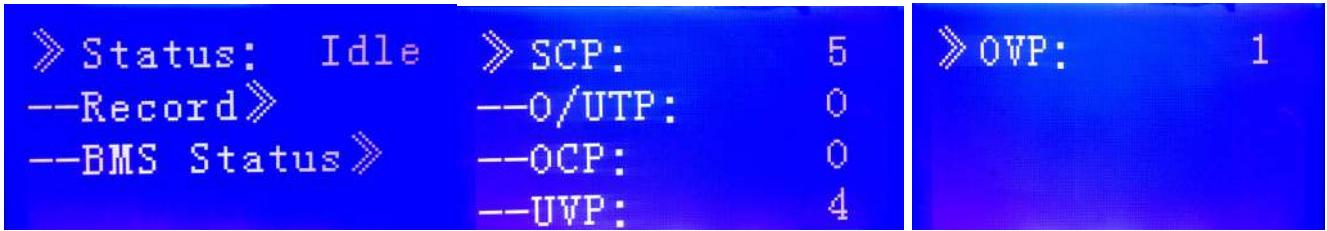

2.6.2.4 Battery Parameters Setting page

When the cursor "»" is point to "Para Setting" , press ENTER key will enter into the page of "Para Setting" , As shown in the figure below:

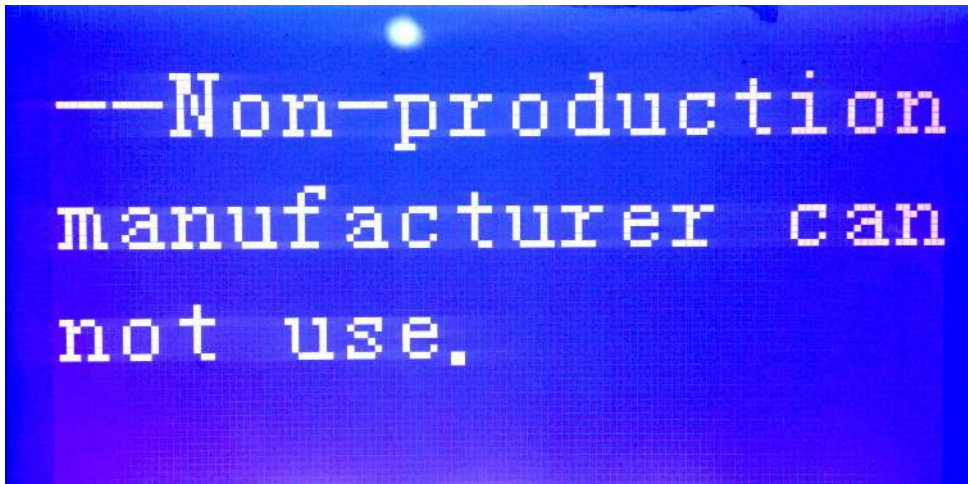

2.6.2.5 Battery System Setting page

When the cursor "»" is point to "Sys setting" , press ENTER key will enter into the page of "Sys setting" , As shown in the figure below:

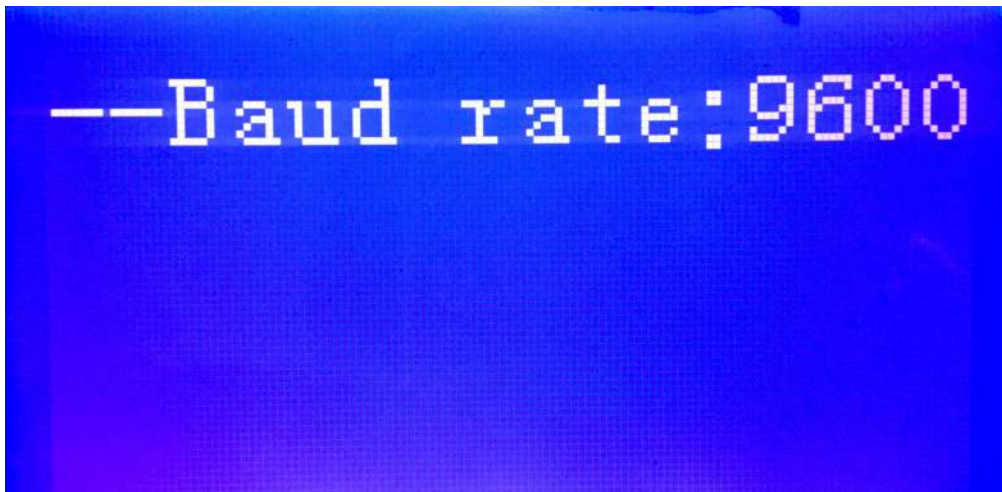

2.7 Connectors

Charge / Discharge connectors: to connect the positive pole (+) and negative pole (-) from the battery to the inverter via DC isolator.

RS485: Active communication portal between battery and inverter.

RS232: To get dynamic monitoring data of the battery from upper computer.

RS485/CAN: To get dynamic monitoring data of the battery from inverter.

Address: Reserved Address portal for multiple parallel connections.

2.8 Wake Up button

Switch on: When battery is shut down, press this button for 1 seconds. It is activated when the LED lights flicker from RUN light to the lowest capacity indicator.

Reset: When battery is activated, press this button for 6 seconds. The battery will be reset and all of the LED lights will be on at same time.

3. Safe handling guide

3.1 System Diagram

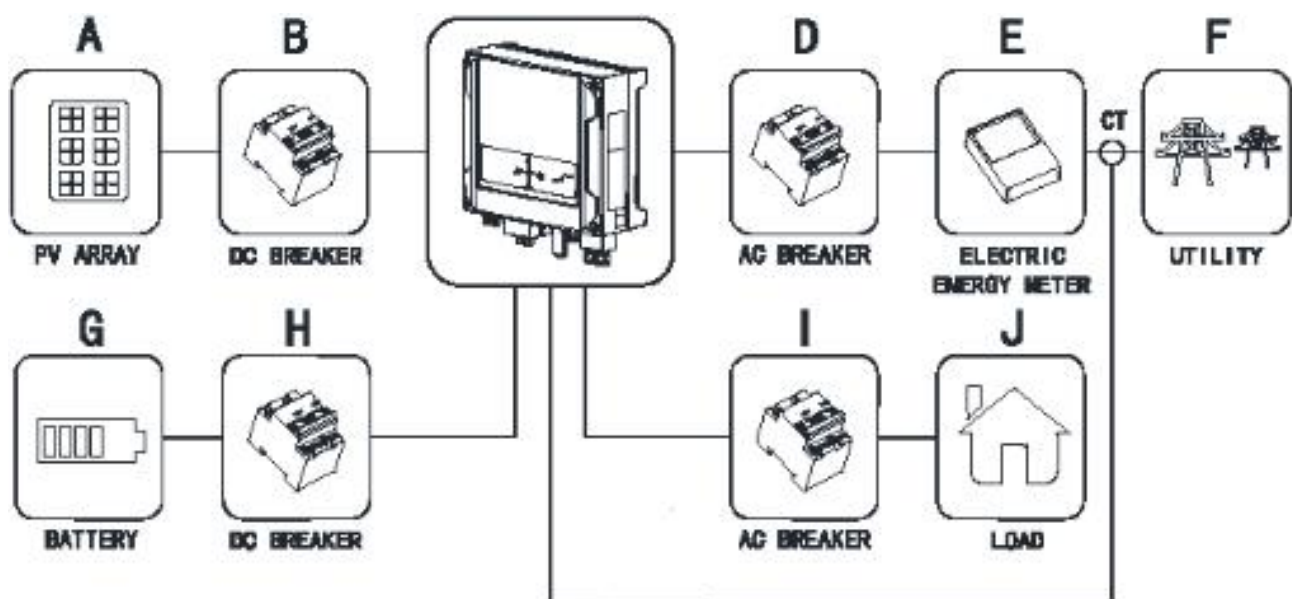

3.2 Tools

The following tools are required to install the battery pack:

- Wire cutter
- Crimping Modular Plier
- Screw Driver

NOTE: Use properly insulated tools to prevent accidental electric shock or short circuits. If insulated tools are not available, cover the entire exposed metal surfaces of the available tools, except their tips, with electrical tape.

3.3 Safety Gear

It is recommended to wear the following safety gear when dealing with the battery pack:

- Insulated gloves
- Safety goggles
- Safety shoes

3.4 Installation

3.4.1 Inventory of items

Thoroughly inspect the packaging upon receipt of goods. If there is any item that is missing or if there is any damage to the external packaging or to the unit itself upon unpacking, please contact the supplier immediately.



A



B



C



D

NO.	Item	Quantity	Remarks
A	Battery Pack	1	14.4/15.36KWh
B	Mounting frame	1	SPCC

C	Mounting frame screw	4	M8*70mm
D	Power cable(1.5M)	2	6AWG Wire-M8 125A/1000V
Option	RS232 Communication Cable	1	Can monitor battery through upper software
Option	Battery-Inverter Communication Cable	1	Battery communicated with inverter

3.4.2 Installation Location

Make sure that the installation location meets the following conditions:

- The installation site must be suitable for the size and weight of the battery.
- Must be installed on a firm surface to sustain the weight of battery.
- The area is water proof.
- There are no flammable or explosive materials in proximity.
- The ambient temperature is within the range from 0°C to 45°C.
- The temperature and humidity is maintained at a constant level.
- There is minimal dust and dirt in the area.
- Installation must be vertical or tilted backwards by maximum 15° - avoid forward or sideways tilt.

3.4.3 Wall-mounted

1. Choose suitable firm wall with thickness greater than 80mm.
2. Use the mounting frame as a template, mark the hole position.
3. Drill 8 holes according to the hole position, it is $\varnothing 10$ with depth 60mm.
4. Hammer the M8 screws to the above holes, and screw the nut.

NOTE: Do not position screws flush to the wall - leave 10 to 20 mm exposed.

5. Fix the mounting frame to the 8 screws.
6. First add a fixed sheet metal to the battery pack, and then install the rear bracket to the wall, push the battery to the wall and fix it through the rear bracket.

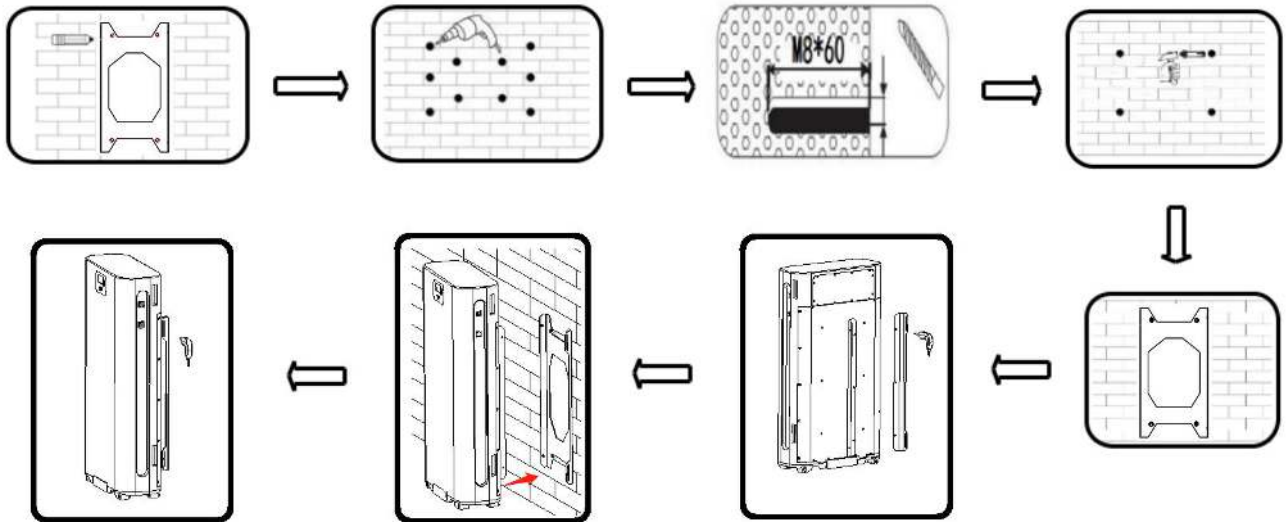

4. Operating intructions

4.1 Software Installation

For optional computer system protection, install battery monitoring software to fully configure battery shutdown and other setting value.

4.2 Pre-operation step

Circuit breaker of battery circuit is set to OFF, connect it to switch power supply, and output voltage of switch power supply is set to 52.5-54V/56-57.6V, current set to 0.2C; after all settings done, switch the circuit breaker ON.

4.3 Communication Function

4.3.1 Communication port definition

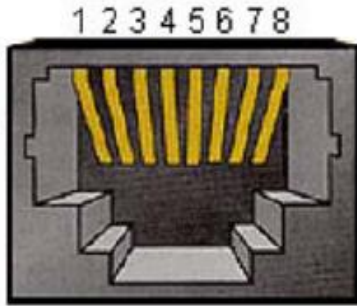

RS485 interface

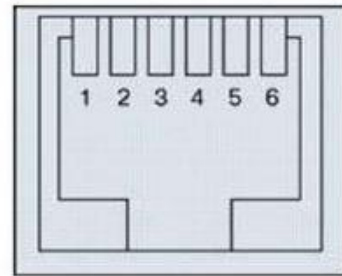

RS232 interface

RS485 Terminal Port	Definition
Pin1, 8	RS485_B
Pin2, 7	RS485_A
Pin3, 6	GND
Pin4, 5	NC

RS485 Communication Port Definition

CAN Terminal Port	Definition
Pin4	CAN H
Pin5	CAN L
Pin7	GND
Pin1,2,3,6,8	NC

CAN Communication Port Definition

RS232 Terminal Port	Definition
Pin3	BMS Transmit, PC Receive
Pin4	BMS Receive, PS Transmit
Pin5	GND
Pin1,2,,6	NC

RS232Communication Port Definition

4.3.2 Battery communicate with PC/Software

4.3.2.1 Single battery communicate with PC/software

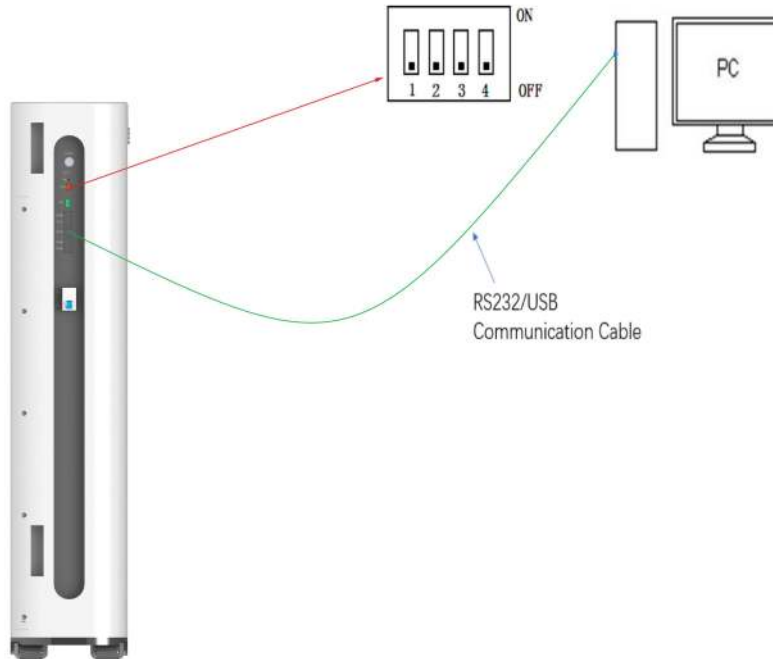

4.3.2.2 Batteries parallel communicate with PC/software

While battery in parallel communication, dial-up addresses of battery are different.

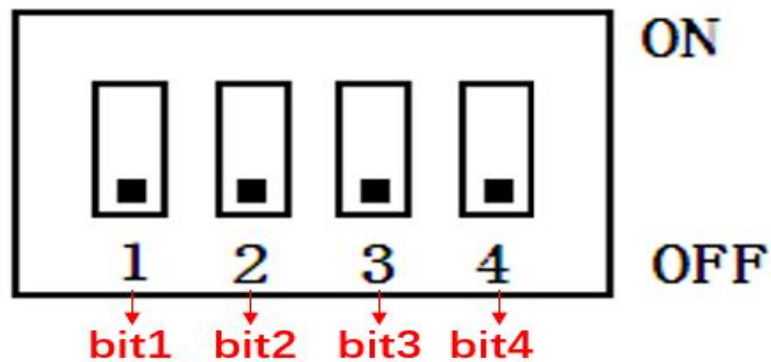

Address	Dial Switch				Remark
	bit1	bit2	bit3	bit4	
1	ON	OFF	OFF	OFF	Battery 1
2	OFF	ON	OFF	OFF	Battery 2
3	ON	ON	OFF	OFF	Battery 3
4	OFF	OFF	ON	OFF	Battery 4
5	ON	OFF	ON	OFF	Battery 5

.....
14	OFF	ON	ON	ON	Battery 14
15	ON	ON	ON	ON	Battery 15

Note: The range of batteries' address bit1-bit4 is 1-15.

For example: 15 sets batteries in parallel communicated with PC/software as below:

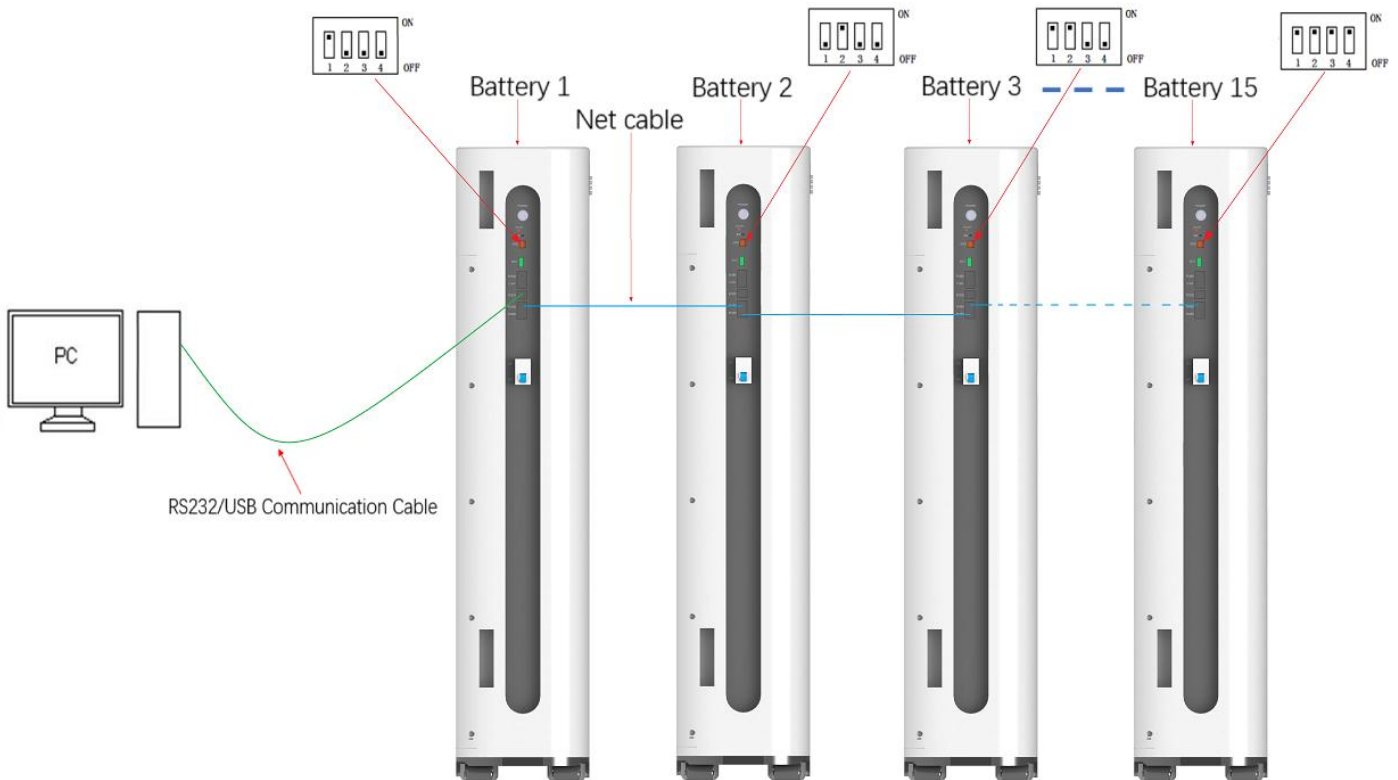

4.3.3 Batteries communicated with inverter

4.3.3.1 Single battery communicate with inverter

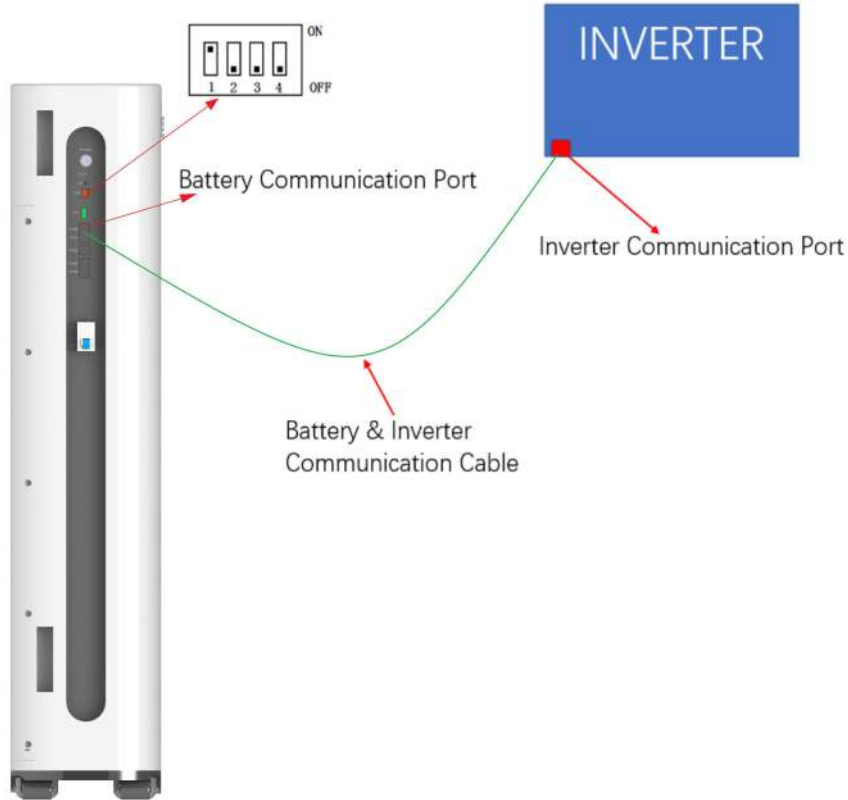

- Note: 1. If communicated with LUX inverter, please connected with RS485 port of battery.
2. If communicated with DEYE inverter, please connected with CAN port of battery.

4.3.3.2 Batteries parallel communicate with inverter

While battery in parallel communication , dial-up addresses of battery are different.

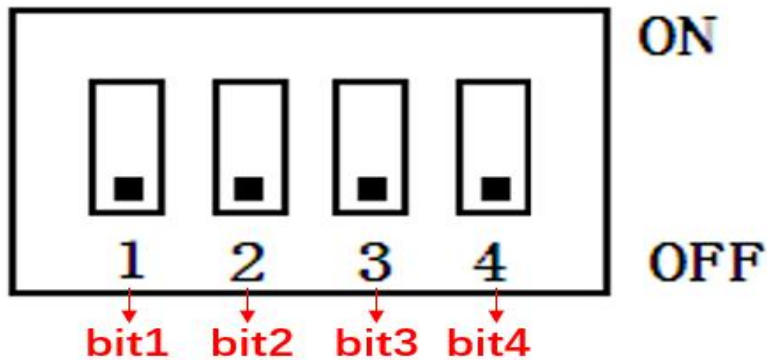

Address	Dial Switch				Remark
	bit1	bit2	bit3	bit4	
1	ON	OFF	OFF	OFF	Battery 1
2	OFF	ON	OFF	OFF	Battery 2
3	ON	ON	OFF	OFF	Battery 3

4	OFF	OFF	ON	OFF	Battery 4
5	ON	OFF	ON	OFF	Battery 5
.....
14	OFF	ON	ON	ON	Battery 14
15	ON	ON	ON	ON	Battery 15

Note: The range of address bit1-bit4 is 1-15.

For example: 15 sets batteries in parallel communicated with inverter as below:

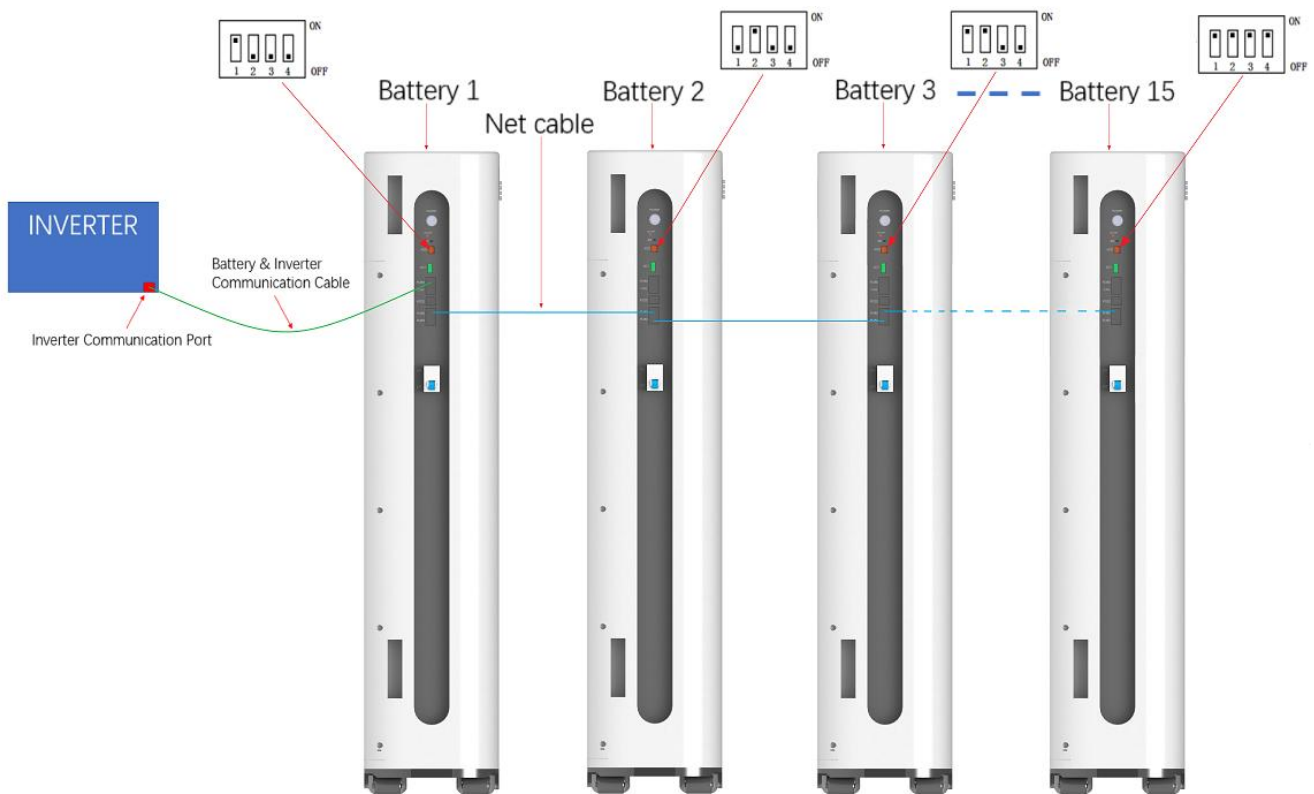

5. Troubleshooting

If the battery does not operate correctly, please solve the problem by using the table below.

Symptom	Possible cause	Remedy
No indication and alarm in the front display panel	Sleeping mode	Press Reset to normal mode
No indication and alarm in the front display panel even Reset still no	Battery voltage too low	Charge battery immediately
Red LED Flashing when Standby	Battery cell low voltage	Charge battery immediately

Red LED Flashing when charging	Alarm for protection when charging	BMS show alarm, protect and adjustment
Red LED Flashing when Discharging	Battery too low and will shutdown	Charge battery immediately
RED LED Lighting continuous	Battery wrong	Need to repair

6. Storage and Maintenance

6.1. Storage

Before storing, charge the battery at least 7 hours. Store the Battery covered and upright in a cool, dry location. Recommend long-term storage temperature is 15°C -25°C . During storage, recharge the battery in accordance with the following table:

Storage Temperature	Recharge Frequency	Charging Duration
0°C - 40°C	Every 3 months	1-2 hours

6.2. Maintenance

 The battery system operates with hazardous voltages. Repairs may be carried out only by qualified maintenance personnel.

 Even after the unit is disconnected from the mains, components inside are still connected to the battery cells which are potentially dangerous.

 Before carrying out any kind of service and/or maintenance, disconnect the batteries and verify that no current is present and no hazardous voltage exists in the terminals.

 Only persons are adequately familiar with batteries and with the required precautionary measures may replace batteries and supervise operations. Unauthorized persons must be kept well away from the batteries.

 Verify that no voltage between the battery terminals and the ground is present before maintenance or repair. In this product, the battery circuit is not isolated from the input voltage. Hazardous voltages may occur between the battery terminals and the ground.



Batteries may cause electric shock and have a high short-circuit current. Please remove all wristwatches, rings and other metal personal objects before maintenance or repair, and only use tools with insulated grips and handles for maintaining or repairing.



When replace the batteries, install the same number and same type of batteries.



When replace the parallel batteries, make sure the new battery is full charged.



Do not open or destroy batteries. Escaping electrolyte can cause injury to the skin and eyes. It may be toxic.



Please replace the fuse only with the same type and amperage in order to avoid fire hazards.



Do not disassemble the battery system.

7 Product Responsibilities and Consulting

- 1) We will not be liable for the accidents resulting from operation breaking this specification and user manual.
- 2) We will not send separate notice, provided that the contents of this specification are changed due to improvement of product quality or technological upgrading; provided that you want to understand the latest information of this product, please contact us.
- 3) The shelf life of this product is within 24 months after it is delivered; we will maintain the product, which is in the warranty period for free of charge, provided that it has any product quality problems within the specified operation range; we may replace the relevant parts, if we fail to maintain it, so as to achieve the purpose of sustainable use without performance reduction; our after-sales service personnel will propose the specific maintenance and troubleshooting methods.
- 4) In case of any questions, please contact us

Warranty Card

Mr/Mrs./Ms/Miss: _____

Telephone Number: _____

Address: _____

E-mail: _____

Purchase Date: _____ / _____ / _____ (DD/MM/YYYY)

Dealer's Name: _____

Dealer's' Telephone Number: _____

Dealer's Address: _____

Serial Number: _____