

System description

SMA FLEXIBLE STORAGE SYSTEM

Increased self-consumption with SUNNY ISLAND 4.4M / 6.0H / 8.0H and
SUNNY HOME MANAGER



Legal Provisions

The information contained in these documents is the property of SMA Solar Technology AG. No part of this document may be reproduced, stored in a retrieval system, or transmitted, in any form or by any means, be it electronic, mechanical, photographic, magnetic or otherwise, without the prior written permission of SMA Solar Technology AG. Internal reproduction used solely for the purpose of product evaluation or other proper use is allowed and does not require prior approval.

SMA Solar Technology AG makes no representations or warranties, express or implied, with respect to this documentation or any of the equipment and/or software it may describe, including (with no limitation) any implied warranties of utility, merchantability, or fitness for any particular purpose. All such representations or warranties are expressly disclaimed. Neither SMA Solar Technology AG nor its distributors or dealers shall be liable for any indirect, incidental, or consequential damages under any circumstances.

The exclusion of implied warranties may not apply in all cases under some statutes, and thus the above exclusion may not apply.

Specifications are subject to change without notice. Every attempt has been made to make this document complete, accurate and up-to-date. Readers are cautioned, however, that product improvements and field usage experience may cause SMA Solar Technology AG to make changes to these specifications without advance notice, or per contract provisions in those cases where a supply agreement requires advance notice. SMA Solar Technology AG shall not be responsible for any damages, including indirect, incidental or consequential damages, caused by reliance on the material presented, including, but not limited to, omissions, typographical errors, arithmetical errors or listing errors in the content material.

SMA Warranty

You can download the current warranty conditions from the Internet at www.SMA-Solar.com.

Trademarks

All trademarks are recognized, even if not explicitly identified as such. Missing designations do not mean that a product or brand is not a registered trademark.

SMA Solar Technology AG

Sonnenallee 1

34266 Niestetal

Germany

Tel. +49 561 9522-0

Fax +49 561 9522-100

www.SMA.de

Email: info@SMA.de

Status: 9/13/2019

Copyright © 2019 SMA Solar Technology AG. All rights reserved.

Table of Contents

1	Information on this Document	4
1.1	Validity	4
1.2	Target Group	4
1.3	Content and Structure of this Document.....	4
1.4	Levels of Warning Messages.....	4
1.5	Symbols in the Document.....	5
1.6	Typographies in the Document	5
1.7	Designation in the document	5
1.8	Additional Information.....	6
2	Safety	7
2.1	Intended Use.....	7
2.2	IMPORTANT SAFETY INSTRUCTIONS.....	8
2.3	Battery Safety Information.....	11
3	Functions and Design	13
3.1	Functions of the SMA Flexible Storage System	13
3.2	Requirements of VDE Application Guide 2510-2	13
3.3	Communication	14
4	System with One Sunny Island	15
4.1	Circuitry Overview for a System with One Sunny Island Inverter	15
4.2	Connection of the Sunny Island.....	16
5	System With Three Sunny Island Inverters	18
5.1	Circuitry Overview for a System with Three Sunny Island Inverters	18
5.2	Connecting the Master.....	19
5.3	Connecting the Slaves.....	20
6	Commissioning	22
6.1	Commissioning Procedure.....	22
6.2	Adjusting the Configuration of the Sunny Island	22
6.3	Commissioning a System With Increased Self-Consumption	23
7	Contact	25

1 Information on this Document

1.1 Validity

This document is valid for the SMA Flexible Storage System with the following device types:

- SI4.4M-13 (Sunny Island 4.4M) from firmware version 3.01.xx.R
- SI6.0H-13 (Sunny Island 6.0H) from firmware version 3.01.xx.R
- SI8.0H-13 (Sunny Island 8.0H) from firmware version 3.01.xx.R
- HM-20 (Sunny Home Manager 2.0) from firmware version 2.00.00.R

1.2 Target Group

The tasks described in this document must only be performed by qualified persons. Qualified persons must have the following skills:

- Knowledge of how an inverter works and is operated
- Knowledge of how batteries work and are operated
- Training in the installation and commissioning of electrical devices and installations
- Knowledge of all applicable laws, standards and directives
- Knowledge of and compliance with this document and all safety information
- Knowledge of and compliance with the documents of the battery manufacturer with all safety information

1.3 Content and Structure of this Document

This document summarizes the specific information for the SMA Flexible Storage System.

Circuitry overviews provide the basic principle of how a system must be connected. The structure of this document specifies the chronological sequence for configuration and commissioning.

This document supplements the documents that are enclosed with each product and does not replace any locally applicable codes or standards. Read and observe all documents supplied with the product.

Illustrations in this document are reduced to the essential information and may deviate from the real product.

1.4 Levels of Warning Messages

The following levels of warning messages may occur when handling the product.

DANGER

Indicates a hazardous situation which, if not avoided, will result in death or serious injury.

WARNING

Indicates a hazardous situation which, if not avoided, could result in death or serious injury.









CAUTION

Indicates a hazardous situation which, if not avoided, could result in minor or moderate injury.

NOTICE

Indicates a situation which, if not avoided, can result in property damage.

1.5 Symbols in the Document

Symbol	Explanation
	Information that is important for a specific topic or goal, but is not safety-relevant
	Indicates a requirement for meeting a specific goal
	Desired result
	A problem that might occur
	Example
	This information is relevant for systems which are to be operated in parallel with utility grid. (e.g. SMA Flexible Storage System).
	
	Content is relevant for off-grid systems.

1.6 Typographies in the Document

Typography	Use	Example
bold	<ul style="list-style-type: none"> Messages Terminals Elements on a user interface Elements to be selected Elements to be entered 	<ul style="list-style-type: none"> Connect the insulated conductors to the terminals X703:1 to X703:6. Enter 10 in the field Minutes.
>	<ul style="list-style-type: none"> Connects several elements to be selected 	<ul style="list-style-type: none"> Select Settings > Date.
[Button] [Key]	<ul style="list-style-type: none"> Button or key to be selected or pressed 	<ul style="list-style-type: none"> Select [Enter].
#	<ul style="list-style-type: none"> Placeholder for variable components (e.g., parameter names) 	<ul style="list-style-type: none"> Parameter WCtlHz.Hz#

1.7 Designation in the document

Complete designation	Designation in this document
SMA Flexible Storage System	Battery storage system
SMA Speedwire	Speedwire
Sunny Boy, Sunny Tripower	PV inverter
Sunny Places, Sunny Portal, Sunny Home Manager	Communication product

1.8 Additional Information

For more information, please go to www.SMA-Solar.com.

Title and information content	Type of information
Mounting, installation, commissioning, operation, configuration, troubleshooting and decommissioning of the inverter	Operating manual
"Parameters and Measured Values" Overview of all inverter operating parameters and their configuration options	Technical Information
"SMA Smart Home" The System Solution for Greater Independence	Planning Guidelines
"SMA Flexible Storage System with Battery Backup Function"	Planning Guidelines

2 Safety

2.1 Intended Use

The SMA Flexible Storage System is a battery storage system and optimizes self-consumption of PV energy by the following measures:

- Intermediate storage of excess PV energy with the Sunny Island
- Visualization of PV system data in Sunny Portal

Loads connected to the Sunny Island must have an CE, RCM or UL identification label.

The SMA Flexible Storage System does not form a battery-backup grid in the event of utility grid failure (for installation of a battery-backup system, see the system description "SMA FLEXIBLE STORAGE SYSTEM with Battery-Backup Function" at www.SMA-Solar.com).

The SMA Flexible Storage System must only be used in those countries for which it is licensed or in those countries for which it is approved by SMA Solar Technology AG and the grid operator. The grid configuration of the utility grid must be a TN or TT system.

Grid feed-in and purchased electricity are recorded with an SMA Energy Meter only. An SMA Energy Meter does not replace the energy meter of the electric utility company.

Single-phase clusters are not permitted. In a three-phase cluster, only device types with the same output power may be installed. This means that the device types, such as SI6.0H-12 and SI6.0H-13, may be combined within a cluster. In contrast, device types with different outputs (e.g. SI6.0H-13 and SI8.0H-13) may not be combined. The cluster master must always be an SI4.4M-13 / SI6.0H-13 / SI8.0H-13. It must be equipped with the latest firmware version.

DC charge controller must not be connected in the battery storage system.

The SMA Flexible Storage System can be installed at altitudes of up to 2000 m above MSL.

The entire battery voltage range must be completely within the permissible DC input voltage range of the Sunny Island. The maximum permissible DC input voltage of the Sunny Island must not be exceeded. A battery fuse must be installed between the battery and the Sunny Island.

With lead-acid batteries, the battery room must be ventilated in accordance with the requirements of the battery manufacturer and with the locally applicable standards and directives (see documentation of the battery manufacturer).

The following conditions must be satisfied for lithium-ion batteries:

- The lithium-ion battery must comply with the locally applicable standards and directives and must be intrinsically safe.
- The battery management of the lithium-ion battery used must be compatible with the Sunny Island (see the technical information at "List of Approved Batteries").

An DC supply grid may not be established with the Sunny Island.

Use SMA products only in accordance with the information provided in the enclosed documentation and with the locally applicable laws, regulations, standards and directives. Any other application may cause personal injury or property damage.

Alterations to the SMA products, e.g., changes or modifications, are only permitted with the express written permission of SMA Solar Technology AG. Unauthorized alterations will void guarantee and warranty claims and in most cases terminate the operating license. SMA Solar Technology AG shall not be held liable for any damage caused by such changes.

Any use of the product other than that described in the Intended Use section does not qualify as the intended use.

The enclosed documentation is an integral part of this product. Keep the documentation in a convenient, dry place for future reference and observe all instructions contained therein.

This document does not replace and is not intended to replace any local, state, provincial, federal or national laws, regulations or codes applicable to the installation, electrical safety and use of the product. SMA Solar Technology AG assumes no responsibility for the compliance or non-compliance with such laws or codes in connection with the installation of the product.

2.2 IMPORTANT SAFETY INSTRUCTIONS

SAVE THESE INSTRUCTIONS

This section contains safety information that must be observed at all times when working.

The product has been designed and tested in accordance with international safety requirements. As with all electrical or electronical devices, there are residual risks despite careful construction. To prevent personal injury and property damage and to ensure long-term operation of the product, read this section carefully and observe all safety information at all times.

DANGER

Danger to life due to electric shock when live components or cables are touched

High voltages are present in the conductive components or cables of the product. Touching live parts and cables results in death or lethal injuries due to electric shock.

- Do not touch non-insulated parts or cables.
- Disconnect the system from voltage sources and make sure it cannot be reconnected before working on the device.
- Observe all safety information on components associated with the product.
- Wear suitable personal protective equipment for all work on the product.

DANGER

Danger to life due to electric shock in case of overvoltages and if surge protection is missing

Overvoltages (e. g. in the event of a flash of lightning) can be further conducted into the building and to other connected devices in the same network via the network cables or other data cables if there is no surge protection. Touching live parts and cables results in death or lethal injuries due to electric shock.

- Ensure that all devices in the same network and the battery are integrated into the existing surge protection.
- When laying the network cables or other data cables outdoors, it must be ensured that a suitable surge protection device is provided at the transition point of the cable from the product or the battery outdoors to the inside of a building.

DANGER

Danger to life due to electric shock in case of overvoltages and unsuitable loads

Overvoltages of up to 1500 V can occur in the stand-alone grid and in the battery-backup grid. If the loads are not suitable for these overvoltages or are not safe to operate, a voltage that poses a danger to life may be present on accessible parts or cables. Touching live parts and cables results in death or lethal injuries due to electric shock.

- Only connect loads that have a CE, RCM or UL designation. These loads are suitable for overvoltages of up to 1500 V.
- Operate the loads only when they are technically faultless and in an operationally safe state.
- Check the loads regularly for visible damage.

⚠ DANGER**Danger to life due to electric shock when operating a damaged product**

Operating a damaged product can lead to hazardous situations since high voltages can be present on accessible product parts. Touching live parts and cables results in death or lethal injuries due to electric shock.

- Only operate the system when it is in a flawless technical condition and safe to operate.
- Check the system regularly for visible damage.
- Make sure that all external safety equipment is freely accessible at all times.
- Make sure that all safety equipment is in good working order.
- Wear suitable personal protective equipment for all work on the product.

⚠ WARNING**Danger to life due to fire or explosion**

In rare cases, an explosive gas mixture can be generated inside the inverter under fault conditions. In this state, switching operations can cause a fire inside the inverter or explosion. Death or lethal injuries due to hot or flying debris can result.

- In the event of a fault, do not perform any direct actions on the inverter.
- Ensure that unauthorized persons have no access to the inverter.
- Disconnect the battery from the product via an external disconnection device.
- Disconnect the AC circuit breaker, or keep it disconnected in case it has already tripped, and secure it against reconnection.
- Only perform work on the inverter (e.g., troubleshooting, repair work) when wearing personal protective equipment for handling of hazardous substances (e.g., safety gloves, eye and face protection, respiratory protection).

⚠ WARNING**Risk of injury due to toxic substances, gases and dusts.**

In rare cases, damages to electronic components can result in the formation of toxic substances, gases or dusts inside the inverter. Touching toxic substances and inhaling toxic gases and dusts can cause skin irritation, burns or poisoning, trouble breathing and nausea.

- Only perform work on the inverter (e.g., troubleshooting, repair work) when wearing personal protective equipment for handling of hazardous substances (e.g., safety gloves, eye and face protection, respiratory protection).
- Ensure that unauthorized persons have no access to the inverter.

⚠ CAUTION**Risk of burns due to short-circuit currents on the disconnected inverter**

The capacitors in the DC input area of the inverter store energy. After the battery is isolated from the inverter, battery voltage is still temporarily present at the DC terminal. A short circuit at the DC terminal of the inverter can lead to burns and may damage the inverter.

- Wait 15 minutes before performing any work at the DC terminal or on the DC cables. This allows the capacitors to discharge.

⚠ CAUTION**Risk of burns due to hot enclosure parts**

Some parts of the enclosure can get hot during operation.

- Mount the inverter in such a way that it cannot be touched inadvertently during operation.

NOTICE**Damage to the system due to sand, dust and moisture ingress**

Sand, dust and moisture penetration can damage the system and impair its functionality.

- Only open the product if the humidity is within the thresholds and the environment is free of sand and dust.
- Do not open the product during a dust storm or precipitation.

NOTICE**Damage to the inverter due to electrostatic discharge**

Touching electronic components can cause damage to or destroy the inverter through electrostatic discharge.

- Ground yourself before touching any component.

NOTICE**Damage to the enclosure seal in subfreezing conditions**

If you open the product when temperatures are below freezing, the enclosure seals can be damaged. Moisture can penetrate the product and damage it.

- Only open the product if the ambient temperature is not below -5°C .
- If a layer of ice has formed on the enclosure seal when temperatures are below freezing, remove it prior to opening the product (e.g. by melting the ice with warm air).

NOTICE**High costs due to inappropriate Internet tariff**

Depending on use, the data volume of the product transferred via the Internet may vary in size. The data volume depends, for example, on the number of inverters in the system, the frequency of device updates, the frequency of data transfer to Sunny Portal or the use of FTP push. High costs for the Internet connection can be the result.

- SMA Solar Technology AG recommends using an Internet flat rate.

i **The inverter supports different firmware versions that are suitable for different systems.**

Inverters using firmware version $\leq 2.99.99.R$ are suitable for off-grid systems and systems that are not subject to the European grid connection conditions in accordance with Regulation (EU) 2016/631 for establishing a network code (also known as RfG). In addition, inverters with firmware version $\leq 2.99.99.R$ may be used in systems that have been commissioned before April 27, 2019, and that are subject to the grid connection conditions of VDE-AR-N 4105:2011-08.

Inverters using a firmware version $\geq 3.00.00.R$ are only suitable for systems that are operated in parallel with the utility grid (e.g. SMA Flexible Storage System). The firmware version $\geq 3.00.00.R$ complies with VDE-AR-N 4105-11:2018, EN50549-1:2018, C10/11:2018 and EREC G98:2018 / G99:2018 of the European grid connection conditions in accordance with Regulation (EU) 2016/631 for establishing a network code (also known as RfG), valid from April 27, 2019 within the EU.

Inverters with a firmware version $\leq 2.99.99.R$ can be identified by the imprint **2:Off-Grid** on the box label. Inverters with a firmware version $\geq 3.00.00.R$ can be identified by the imprint **1:On-Grid** on the box label.

- Ensure that the inverter is equipped with a firmware version that are suitable for the respective system.

i **Change to the names and units of grid parameters to comply with the grid-connection requirements in accordance with Regulation (EU) 2016/631 (valid from April 27, 2019)**

To comply with the EU grid-connection requirements (valid from April 27, 2019) the names and units of grid parameters were changed. The change is valid from firmware version $\geq 3.00.00.R$. Names and units of grid parameters for inverters with firmware version $\leq 2.99.99.R$ are not affected by this change and remain valid.

2.3 Battery Safety Information

This section contains safety information that must be observed at all times when working on or with batteries.

To prevent personal injury or property damage and to ensure long-term operation of the batteries, read this section carefully and observe all safety information at all times.

WARNING

Danger to life due to incompatible lithium-ion battery

An incompatible lithium-ion battery can lead to a fire or an explosion. With incompatible lithium-ion batteries, it is not ensured that battery management is intrinsically safe and will protect the battery.

- Ensure that the lithium-ion batteries are approved for use with the Sunny Island (see technical information "List of Approved Batteries" at www.SMA-Solar.com).
- If no lithium-ion batteries approved for the inverter can be used, lead-acid batteries can be used.
- Verify that the battery complies with locally applicable standards and directives and is intrinsically safe.

WARNING

Danger to life due to explosive gases

Explosive gases may escape from the battery and cause an explosion.

- Protect the battery environment from open flames, embers and sparks.
- Install, operate and maintain the battery in accordance with the manufacturer's specifications.
- Do not burn the battery and do not heat it beyond the permitted temperature.
- Additional measures for lead-acid batteries: Ensure that the battery room is sufficiently ventilated.

⚠ WARNING**Chemical burns due to battery electrolyte**

If handled inappropriately, battery electrolyte can leak from the battery and cause irritation to the eyes, respiratory system and skin.

- Install, operate, maintain and dispose of the battery according to the manufacturer's specifications.
- Whenever working on the battery, wear suitable personal protective equipment such as rubber gloves, an apron, rubber boots and goggles.
- Rinse acid splashes thoroughly for a long time with clear water, and consult a doctor immediately.
- If acid fumes have been inhaled, consult a doctor immediately.

⚠ WARNING**Danger to life due to burns caused by electric arcs through short-circuit currents**

Short-circuit currents in the battery can cause heat build-up and electric arcs. Heat build-up and electric arcs may result in lethal injuries due to burns.

- Remove watches, rings and other metal objects prior to carrying out any work on the battery.
- Use insulated tools for all work on the battery.
- Do not place tools or metal parts on the battery.
- Observe all safety information of the battery manufacturer.

⚠ CAUTION**Risk of burns due to hot battery components**

Improper battery connection may result in excessively high transition resistances. Excessive transition resistances give rise to localized heat build-up.

- Ensure that all pole connectors are connected with the connecting torque specified by the battery manufacturer.
- Ensure that all DC cables are connected with the connecting torque specified by the battery manufacturer.

NOTICE**Damage to the battery due to incorrect settings**

The set battery parameters influence the charging behavior of the inverter. The battery can be damaged by incorrect settings of the battery type, nominal voltage and capacity parameters.

- Set the correct battery type as well as the correct values for nominal voltage and battery capacity when configuring.
- Ensure that the values recommended by the manufacturer are set for the battery (refer to the technical data of the battery in the manufacturer documentation).

3 Functions and Design

3.1 Functions of the SMA Flexible Storage System

The SMA Flexible Storage System supports increased self-consumption through the following measures:

- Intermediate storage of excess PV energy with Sunny Island
- Load control and PV system monitoring with Sunny Home Manager

The Sunny Island uses the connected battery for the intermediate storage of excess PV energy. To do this, Sunny Island measures, for example, the grid feed-in and the purchased electricity with the Sunny Home Manager 2.0. The battery management uses this data to regulate the charging and discharging of the battery. The data for the grid feed-in and for purchased electricity are transmitted to the Sunny Island via Speedwire.

If the Sunny Home Manager is connected to the Internet, the Sunny Home Manager receives location-based weather forecasts and uses them to create yield forecasts for the PV system. In addition, the Sunny Home Manager determines how much energy is typically consumed in a household at different times of the day and uses this to create a load profile of the household. The Sunny Home Manager uses the production forecast and the load profile to determine favorable times for increased self-consumption and selectively switches, for example, the loads connected to the SMA radio-controlled sockets on and off. If required by the grid operator, the Sunny Home Manager also monitors the active power feed-in of the PV system. If the set maximum value for active power feed-in is exceeded, the Sunny Home Manager sends power reduction commands to the SMA PV inverters.

Preventing Derating Losses

The SMA Flexible Storage System prevents derating losses which may arise due to the limitation of active power feed-in. This is achieved by regulating the operation times of time-independent loads and the time and duration of battery charging in accordance with the PV production forecast and the consumption forecast.

Example:

The current daily forecast of the system predicts a limitation of active power feed-in around noon when the energy requirement of the loads is very low and PV production is high. For this reason, derating losses can be expected.

According to this forecast, the system only begins to charge the battery in the late morning. The derating losses will be reduced or avoided by charging the battery at this later time. The total excess PV energy generated in the morning will be fed into the utility grid without derating losses (for details on power control, see planning guidelines "SMA Smart Home").

Deactivating the Increased Self-Consumption Function during Certain Charging Procedures

When using lead-acid batteries, the SMA Flexible Storage System carries out full and equalization charges on a regular basis (see technical information "Battery Management" at www.SMA-Solar.com). During this charging process, the increased self-consumption function is deactivated and electricity may have to be purchased to perform the full and equalization charges.

Regular full and equalization charges increase the service life of lead-acid batteries.

3.2 Requirements of VDE Application Guide 2510-2

The requirements below apply only for systems for which the following properties are all applicable:

- The system is a system with increased self-consumption (SMA Flexible Storage System) or a system with increased self-consumption and battery-backup function (battery-backup system).
- The grid operator or the locally applicable standards and guidelines require compliance with the above-mentioned Application Guide.

Currently, only the grid operators in Germany require compliance with the above-mentioned Application Guide.

In accordance with the scope of VDE application guide 2510-2, a manufacturer's system is regarded as a complete energy storage system only if products are used that have been approved by the manufacturer at hand (see the technical information "List of Approved Batteries"; for a battery-backup system also refer to the planning guidelines "SMA Flexible Storage System with Battery Backup Function", and for the SMA Flexible Storage System to the planning guidelines "SMA Smart Home"). If products are used that have not been approved by SMA Solar Technology AG, the installer is deemed to be the manufacturer of the system.

The requirements of VDE application guide 2510-2 are fulfilled if the installation is carried out in the accordance with the technical documentation of the battery inverter.

3.3 Communication

Requirements for the Speedwire network

The battery inverter and the Sunny Home Manager 2.0 can be directly interconnected via Speedwire. If more than two devices are to communicate via Speedwire or the Sunny Home Manager 2.0 is to establish an internet connection to the Sunny Portal, a Speedwire network is required.

Requirements:

- All Speedwire devices must be connected to the same router.
- The router and the optional network switch must fully support Multicast.
- The router must support "Internet Enabled Devices" with the SIP and STUN interfaces.

Most common routers and network switches support Multicast and "Internet Enabled Devices".

4 System with One Sunny Island

4.1 Circuitry Overview for a System with One Sunny Island Inverter

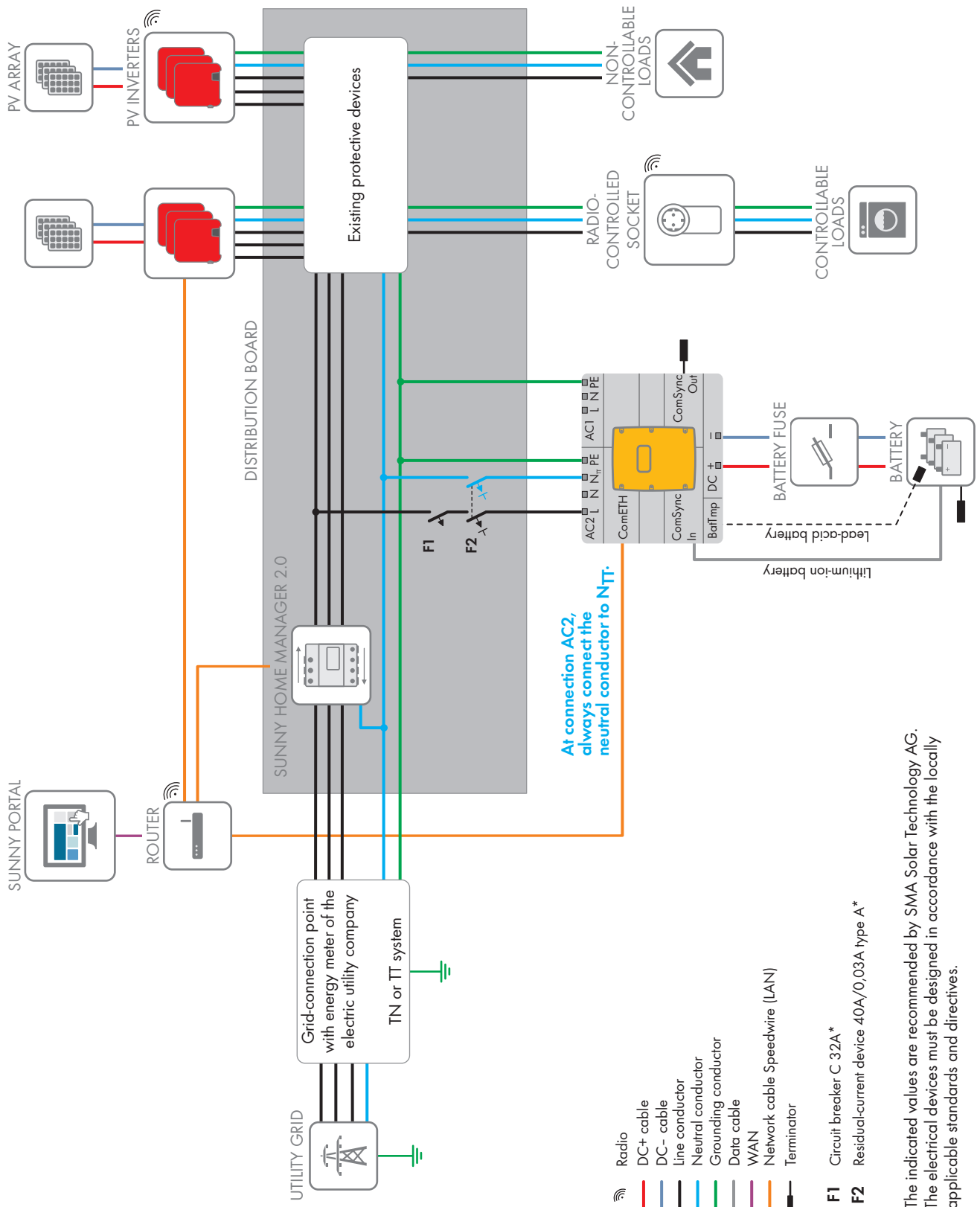

Figure 1: Circuitry of the SMA Flexible Storage System for TN and TT systems

4.2 Connection of the Sunny Island

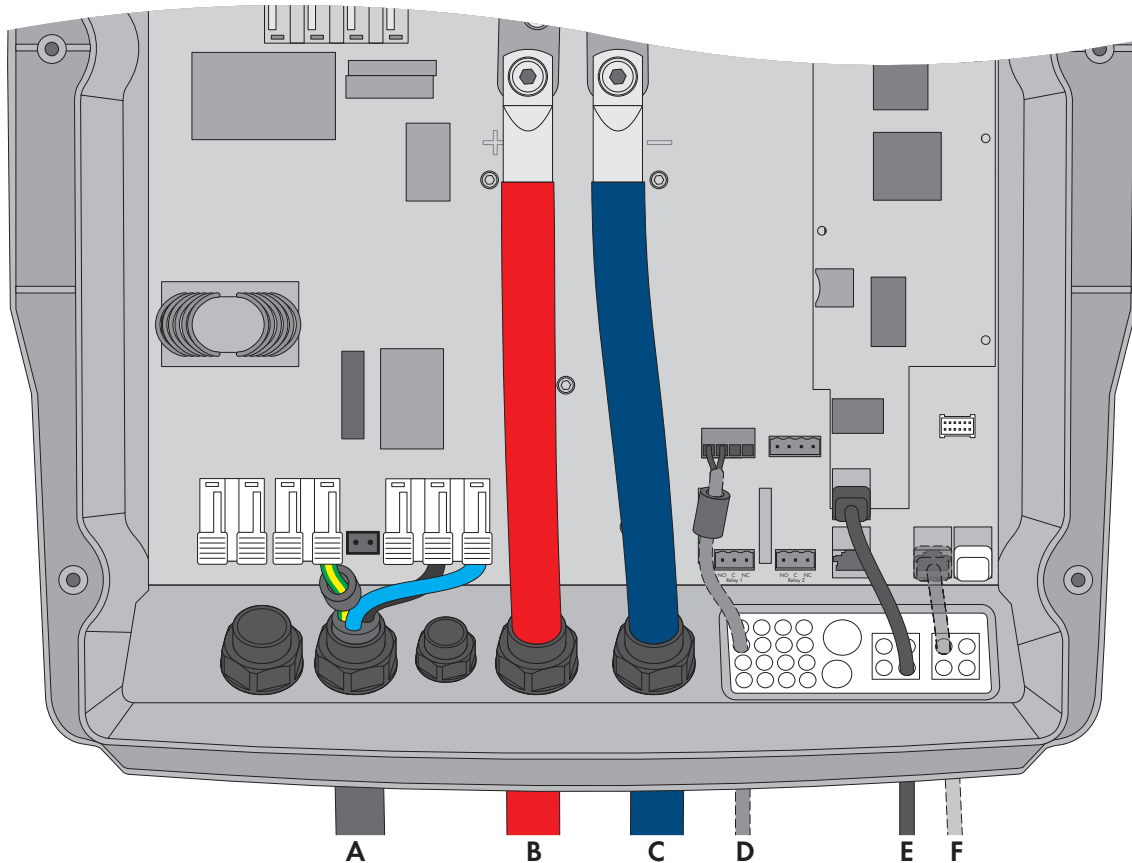

Figure 2: Connection of the Sunny Island

Position	Designation	Description / information
A	AC power cable	Terminal AC2 Gen/Grid terminals L , N_{TT} and PE Utility grid connection with a three-wire cable Conductor cross-section: from 6 mm ² to 16 mm ² Only use the supplied ferrite for PE .
B	DC+ cable	Battery connection
C	DC- cable	Conductor cross-section: from 50 mm ² to 95 mm ² Cable diameters: 14 mm to 25 mm
D	Measuring cable of the battery temperature sensor	Terminal BatTmp You only have to connect a battery temperature sensor if lead-acid batteries are used. Mount the battery temperature sensor in the middle of the battery-storage system, in the upper third of the battery cell. Use the supplied ferrite.

Position	Designation	Description / information
E	Speedwire network cable	Terminal ComETH
F	Data cable to lithium-ion battery	Terminal ComSyncln Connection of the battery management of the lithium-ion battery The communication bus must be connected to the lithium-ion battery and the terminator must remain plugged into the terminal ComSyn-cOut .

5 System With Three Sunny Island Inverters

5.1 Circuitry Overview for a System with Three Sunny Island Inverters

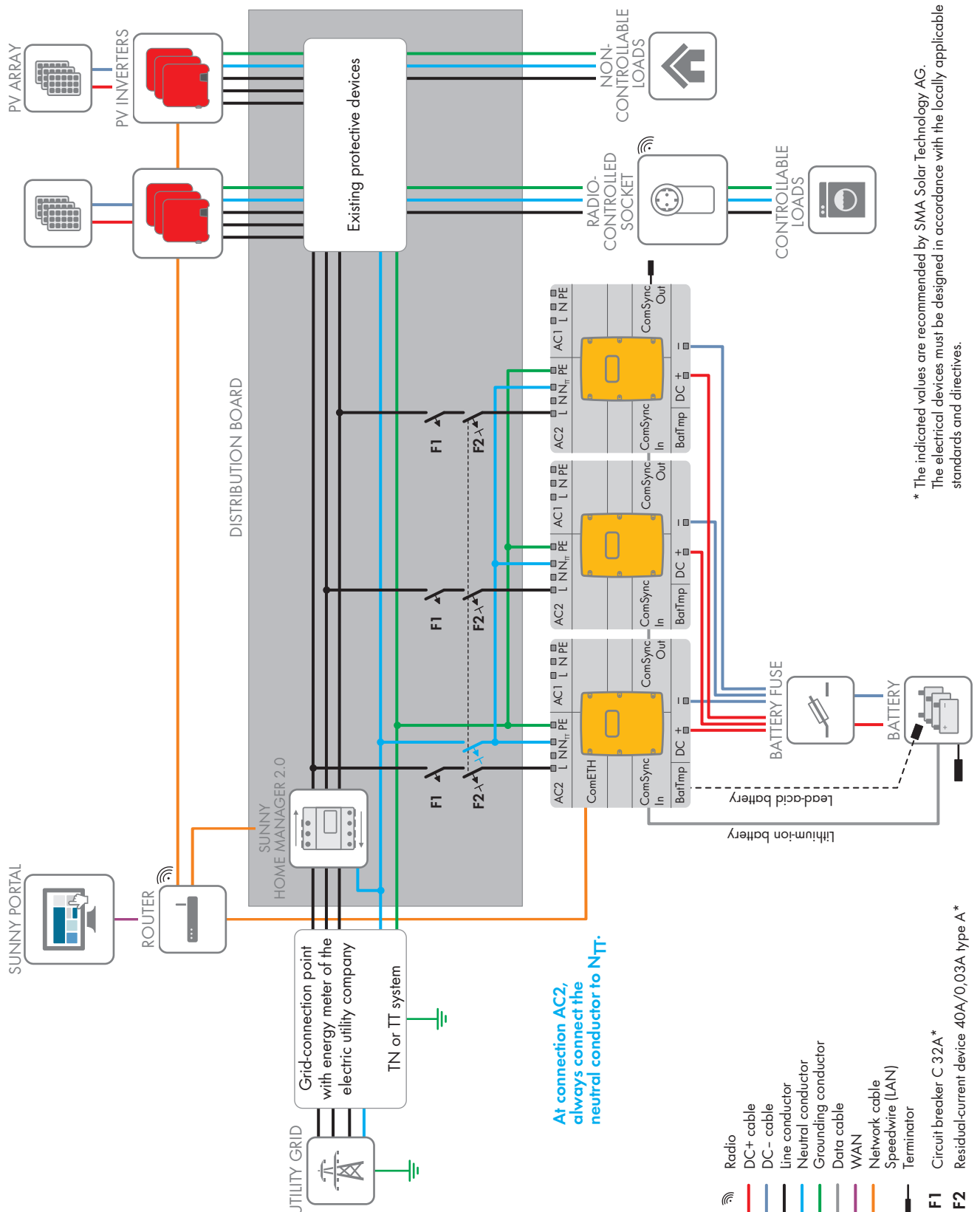

Figure 3: SMA Flexible Storage System for TN and TT systems

5.2 Connecting the Master

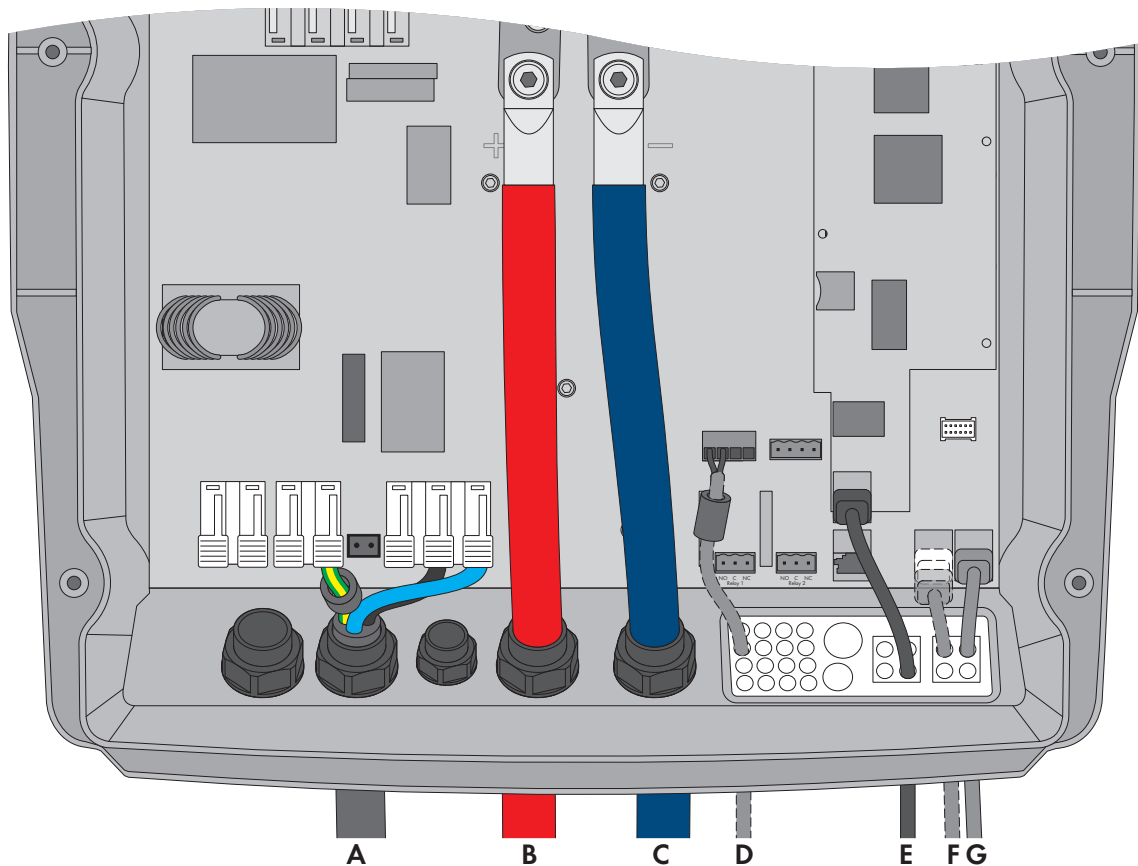

Figure 4: Connection of the master

Position	Designation	Description / information
A	AC power cable	Terminal AC2 Gen/Grid terminals L , N_{IT} and PE Utility grid connection with a three-wire cable to the line conductor L1 Conductor cross-section: from 6 mm ² to 16 mm ² Only use the supplied ferrite for PE .
B	DC+ cable	Battery connection
C	DC- cable	Conductor cross-section: from 50 mm ² to 95 mm ² Cable diameters: 14 mm to 25 mm
D	Measuring cable of the battery temperature sensor	Terminal BatTmp You only have to connect a battery temperature sensor if lead-acid batteries are used. Mount the battery temperature sensor in the middle of the battery-storage system, in the upper third of the battery cell. Use the supplied ferrite.
E	Speedwire network cable	Terminal ComETH

Position	Designation	Description / information
F	Data cable to lithium-ion battery	Terminal ComSynIn Connection of the battery management of the lithium-ion battery The communication bus must be connected to the lithium-ion battery. If no lithium-ion batteries are used, plug the terminator into the terminal ComSynIn .
G	Data cable for the internal communication in the cluster	Terminal ComSyncOut Connection of internal communication bus of Slave 1

5.3 Connecting the Slaves

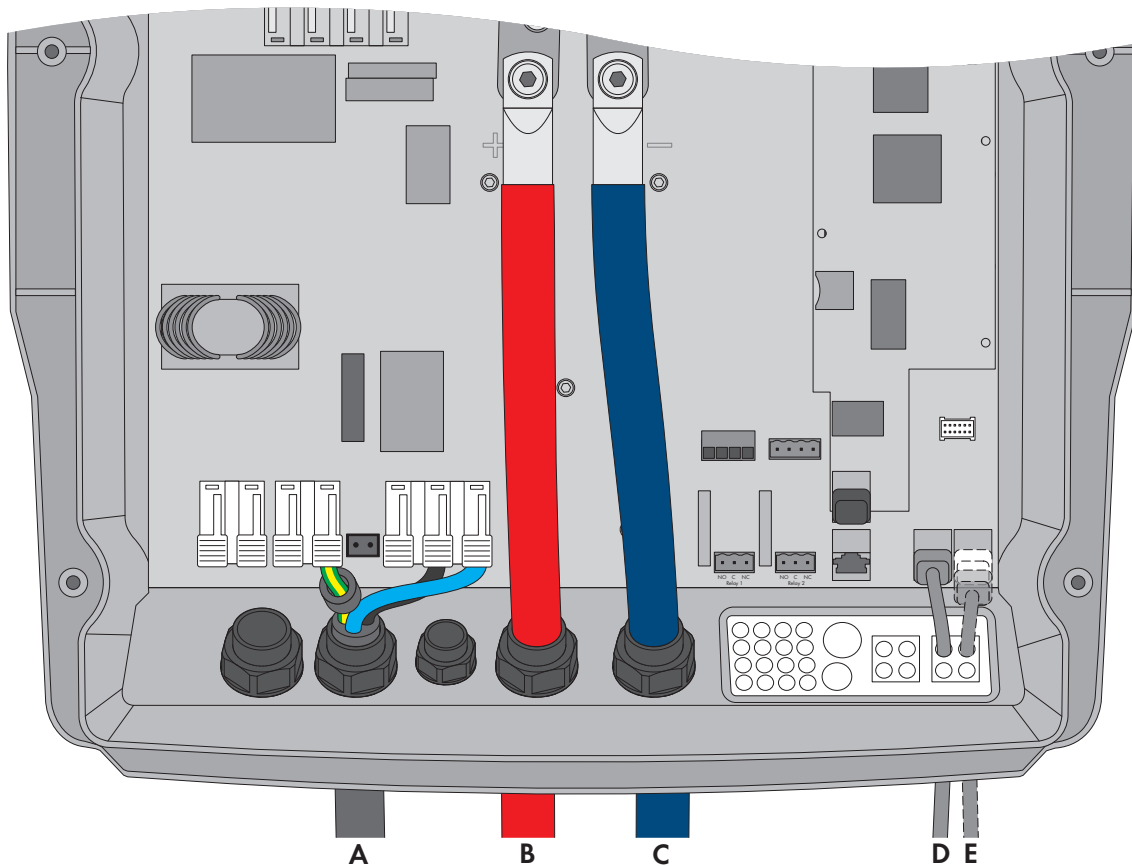

Figure 5: Connection of the slave

Position	Designation	Description / information
A	AC power cable	Terminal AC2 Gen/Grid terminals L , N_T and PE Utility grid connection with a three-wire cable Connect slave 1 to line conductor L2, connect slave 2 to line conductor L3. Conductor cross-section: from 6 mm ² to 16 mm ² Only use the supplied ferrite for PE .
B	DC+ cable	Battery connection
C	DC- cable	Conductor cross-section: from 50 mm ² to 95 mm ² Cable diameters: 14 mm to 25 mm

Position	Designation	Description / information
D	Data cable for the internal communication in the cluster	Terminal ComSyncIn With slave 1: connection of internal communication bus of the master With slave 2: connection of internal communication bus of slave 1
E	Data cable for the internal communication in the cluster	Terminal ComSyncOut With slave 1: connection of internal communication bus of slave 2 With slave 2: leave terminator plugged in. Slave 2 is connected to slave 1 only.

6 Commissioning

6.1 Commissioning Procedure

Before commissioning the system, you must make various settings. This section describes the procedure and gives an overview of the steps, which must always be performed in the prescribed sequence.

Procedure	See
1. Commission the inverter.	Sunny Island operating manual
2. Establish a connection to the user interface of the inverter. There are the following connection options available to choose from: <ul style="list-style-type: none"> • Direct connection via WLAN • Direct connection via Ethernet • Connection via Ethernet in the local network 	Sunny Island operating manual
3. Log into the user interface.	Sunny Island operating manual
4. Perform the basic configuration via the installation assistant: <ul style="list-style-type: none"> • Single system (system with one Sunny Island) • Single-cluster-system (system with three Sunny Island) Please note, that the personal SMA Grid Guard code for changing the grid-relevant parameters must be available after completion of the first ten operating hours (see "Application for the SMA Grid Guard code" available at www.SMA-Solar.com).	Sunny Island operating manual
5. Adjust the configuration of the Sunny Island.	Section 6.2, page 22
6. Commission the SMA Flexible Storage System	Section 6.3, page 23

6.2 Adjusting the Configuration of the Sunny Island

In the SMA Flexible Storage System, the Sunny Island inverters are connected to the utility grid and must meet the requirements of the grid operators. With the firmware version $\geq 3.00.00.R$, the Sunny Island complies with VDE-AR-N 4105-11:2018, EN50549-1:2018, C10/11:2018 and EREC G98:2018 / G99:2018 of the European grid connection conditions in accordance with regulation (EU) 2016/631. These requirements are included in the country data sets of the Sunny Island.

In case of Switzerland, the country data set **DE VDE-AR-N4105** must be selected and the configuration adjusted according to the specifications of the grid operator.

Use in other countries is possible with the agreement of the grid operator. Consult with the grid operator which country data set must be selected and whether an adjustment is necessary.

Requirements:

- The grid-relevant parameters must be changed within the first ten operating hours of the inverter, otherwise the SMA Grid Guard code must be available (see "Application for SMA Grid Guard Code" at www.SMA-Solar.com).

Procedure:

1. Activate the user interface of the inverter (see the inverter operating manual).
2. Log in as Installer.
3. For installation in Switzerland, carry out the following steps:
 - In the parameter group Grid monitoring > Grid monitoring, select the parameter Set country standard.

- Set the country data set **DE VDE-AR-N4105**.

6.3 Commissioning a System With Increased Self-Consumption

i Deactivation of the intermediate storage of PV energy during certain charging procedures

When using lead-acid batteries, the SMA Flexible Storage System carries out full and equalization charges on a regular basis (see technical information "Battery Management" at www.SMA-Solar.com). During this charging process, the increased self-consumption function is deactivated and electricity may have to be purchased to perform the full and equalization charges.

Regular full and equalization charges increase the service life of lead-acid batteries.

i Representation of Sunny Island in Sunny Portal

The Sunny Island inverters of a three-phase cluster will be displayed as one device in Sunny Portal. The data is either added up via the three phases or displayed for each Sunny Island as a phase-specific single value.

Required data for registration in Sunny Portal:

Device / customer data	Required data and explanation
Sunny Home Manager 2.0	<ul style="list-style-type: none"> • Serial number (PIC) and registration ID (RID) Register the new system in Sunny Portal using the PIC and RID. • Only when two SMA Energy Meters are installed, note down the serial number and purpose (e.g. PV production meter) in each case. This way you can identify the energy meters in the Sunny Portal.
PV inverter	<ul style="list-style-type: none"> • System Password The PV system password is the same as the device password for the user group "Installer." All devices of a system must be set to a uniform installer password. • Serial number of the PV inverters You can uniquely identify the PV inverters in Sunny Portal using the serial number. • PV array power in kWp
Radio-controlled socket	<ul style="list-style-type: none"> • The serial number and connected load of each SMA radio-controlled socket In Sunny Portal, configure the SMA radio-controlled socket in accordance with the requirements of the connected load. To do so, you require the serial number of the SMA radio-controlled socket.
Customer data	<ul style="list-style-type: none"> • E-mail address • Password for Sunny Portal access • Address of the PV system • Electricity tariff data <ul style="list-style-type: none"> - Electricity price for purchased electricity - Tariff times, if applicable (e.g. for tariffs with peak and off-peak tariff) - Feed in tariff - Self-consumption tariff, if applicable

Requirements:

- The basic configuration of the Sunny Island must have been performed (see the Sunny Island operating manual).
- All other Speedwire devices must be connected to the same router.
- The router must meet the requirements for the design of a Speedwire communication network (see Section 3.3, page 14).

Procedure:

1. In the distribution board, switch on circuit breaker **F1** and residual-current device **F2**.
2. Commission the PV system (see PV inverter documentation).
3. Press the start-stop button on the Sunny Island and hold it until an acoustic signal sounds. This starts the system.

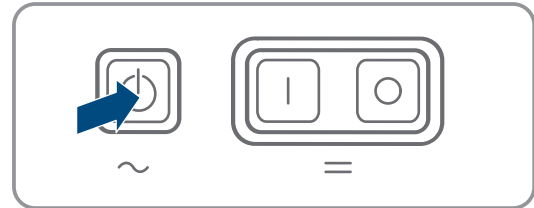

4. Only when one Sunny Home Manager 2.0 and one SMA Energy Meter are installed in the local network, assign the grid feed-in meter and purchased electricity meter to the Sunny Island via the user interface. To do this, enter the serial number of the grid feed-in meter and purchased electricity meter (see the Sunny Explorer operating manual).
5. Open Sunny Portal via www.SunnyPortal.com/Register and run the PV System Setup Assistant. The required data for registration in Sunny Portal must be at hand.
6. Activate the automatic update of the Sunny Home Manager and the PV system in Sunny Portal.
7. In order to activate the forecast-based charging function, call up the device properties of the Sunny Home Manager in Sunny Portal and activate the **Forecast-based battery charging** checkbox. For further information on the forecast-based battery charging, see planning guidelines "SMA Smart Home").
8. Only in systems with active power limitation, ensure that the limitation of the active power feed-in is configured and functioning in Sunny Portal ("Configuring Active Power Feed-In Limitation", see the operating manual of the Sunny Home Manager at www.SunnyPortal.com).

7 Contact

If you have technical problems with our products, please contact the SMA Service Line. The following data is required in order to provide you with the necessary assistance:

- Type of system installed (e.g. three-phase single-cluster system)
- Battery inverter:
 - Device type
 - Quantity
 - Serial numbers
 - Firmware version
 - Event message
 - File with event messages for troubleshooting
 - Service files for troubleshooting
- Type of the communication products connected
- Type and size of additional energy sources
- Type, power and maximum current for the generator (if present)
- Batteries:
 - Type
 - Nominal capacity and nominal voltage (with lead-acid batteries)

Deutschland	SMA Solar Technology AG	Belgien	SMA Benelux BVBA/SPRL
Österreich	Niestetal	Belgique	Mechelen
Schweiz	Sunny Boy, Sunny Mini Central, Sunny Tripower, Sunny Highpower: +49 561 9522-1499	België	+32 15 286 730
	Monitoring Systems (Kommunikationsprodukte): +49 561 9522-2499	Luxemburg	for Netherlands: +31 30 2492 000
	Hybrid Controller: +49 561 9522-3199	Luxembourg	SMA Online Service Center: www.SMA-Service.com
	Sunny Island, Sunny Boy Storage, Sunny Backup: +49 561 9522-399	Nederland	
	Sunny Central, Sunny Central Storage: +49 561 9522-299	Česko	SMA Service Partner TERMS a.s.
	SMA Online Service Center: www.SMA-Service.com	Magyarország	+420 387 6 85 111
		Slovensko	SMA Online Service Center: www.SMA-Service.com
		Türkiye	SMA Service Partner DEKOM Ltd. Şti. +90 24 22430605
			SMA Online Service Center: www.SMA-Service.com
France	SMA France S.A.S. Lyon +33 472 22 97 00	Ελλάδα	SMA Service Partner AKTOR FM.
	SMA Online Service Center : www.SMA-Service.com	Κύπρος	Αθήνα +30 210 8184550
			SMA Online Service Center: www.SMA-Service.com

España Portugal	SMA Ibérica Tecnología Solar, S.L.U. Barcelona +34 935 63 50 99 SMA Online Service Center: www.SMA-Service.com	United Kingdom	SMA Solar UK Ltd. Milton Keynes +44 1908 304899 SMA Online Service Center: www.SMA-Service.com
Italia	SMA Italia S.r.l. Milano +39 02 8934-7299 SMA Online Service Center: www.SMA-Service.com	Australia	SMA Australia Pty Ltd. Sydney Toll free for Australia: 1800 SMA AUS (1800 762 287) International: +61 2 9491 4200
United Arab Emirates	SMA Middle East LLC Abu Dhabi +971 2234 6177 SMA Online Service Center: www.SMA-Service.com	India	SMA Solar India Pvt. Ltd. Mumbai +91 22 61713888
ไทย	SMA Solar (Thailand) Co., Ltd. กรุงเทพฯ +66 2 670 6999	대한민국	SMA Technology Korea Co., Ltd. 서울 +82-2-520-2666
South Africa	SMA Solar Technology South Africa Pty Ltd. Cape Town 08600SUNNY (08600 78669) International: +27 (0)21 826 0699 SMA Online Service Center: www.SMA-Service.com	Argentina Brasil Chile Perú	SMA South America SPA Santiago de Chile +562 2820 2101
Other coun- tries	International SMA Service Line Niestetal 00800 SMA SERVICE (+800 762 7378423) SMA Online Service Center: www.SMA-Service.com		

