

USER MANUAL

8KVA-12KVA OGM Series Hybrid Inverter

Sate

©Copyright, copying and plagiarism without any authorization is prohibited

©The company is committed to the continuous improvement of the inverter. This information is subject to change without notice. please refer to the actual product.

Contents

1. Product introduction	1
2. Product features.....	1
3. Working principle.....	1
4. Introduction to working mode	2
5. Appearance introduction.....	5
6. Installation instructions	7
7. Operation and maintenance	9
8. Inverter startup procedure	10
9. Emergency shutdown procedure	10
10. Operation interface description	10
11. Technical parameters	16
12. Causes and solutions of common failures	17
13. Packing list	17

1. Product description:

8KVA-12KVA OGM series MPPT inverter control all-in-one machine is a highly intelligent product integrating digitization, informationization and networking. It has a powerful information acquisition system, signal processing system, detection system and perfect protection system. It is widely used in a variety of electrical environments, personalized design, and friendly man-machine dialogue. The touch screen LCD is the latest power display module developed by the company and adopts today's popular intuitive graphical operation interface. Compared with the general LCD display module, the touch screen display module has no complicated operation steps. The user can directly click the analog button on the display to obtain the corresponding information, and the operation is simple and easy to understand.

2. Features:

- 2.1. The inverter adopts DSP, MCU and DDC real-time processing all-digital vector control technology to accurately control various parameters of the machine and fully control it.
- 2.2. The combination of advanced IGBT high frequency pulse width modulation technology (MPPT) reduces system noise and power loss, ensuring that customers can obtain high-quality voltage output and the highest benefits under various workload conditions.
- 2.3. The output of the machine with isolation transformer and equipped with isolation transformer will not have DC components in the load, which can effectively protect the switching power supply of computers, networks and communication equipment from DC current damage. At the same time, it can also be used for non-linear loads. It exhibits excellent dynamic performance, improves the load capacity of the machine, and has good load compatibility.
- 2.4. Complete protection functions, with AC input over voltage and under voltage protection, output over voltage and under voltage protection, output overload short-circuit protection, battery under voltage warning protection, internal over-temperature protection, which greatly guarantees the operation of the system Stability and reliability.
- 2.5. The use of high-power IGBT devices makes the inverter have strong overload capacity and shock resistance, and at the same time enhances the adaptability to the power grid.

3. working principle:

The 8KVA-12KVA OGM series MPPT inverter control all-in-one machine is highly integrated with digital technology to improve MTBF and reliability. It adopts MCU high-speed microprocessor control to ensure stable and reliable operation of the equipment.

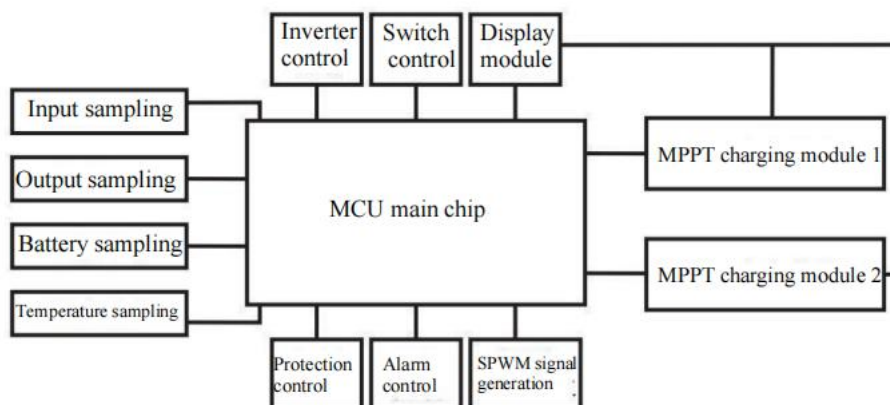

4. Work mode introduction:

The 8KVA-12KVA OGM series inverters have two working modes: battery priority mode (DC Priority) and mains priority mode (AC Priority).

4.1. Battery priority mode (DC Priority):

When the battery voltage is normal, regardless of whether the mains (or diesel engine) input is normal or not, the inverter works by inverting the battery's direct current into alternating current to supply power to the load. When the battery voltage is too low, the inverter automatically switches to the mains ((Or diesel engine) to supply power to the load, but not to charge the battery. After the battery is fully charged by the photovoltaic panel, the inverter will automatically switch to battery inverter to supply power to the load. This mode is suitable for new energy systems such as photovoltaic power generation and wind power generation.

(1) In battery priority mode, when the photovoltaic panel is generating electricity in sufficient sunlight, the system works as shown in the figure below:

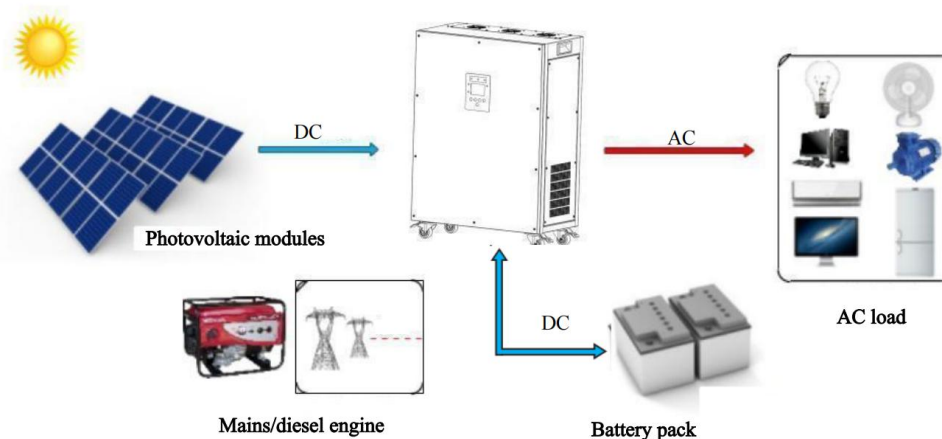

(2) In battery priority mode, when the photovoltaic panel does not generate electricity at night or on a cloudy or rainy day and the battery voltage is normal, the system works as shown in the figure below:

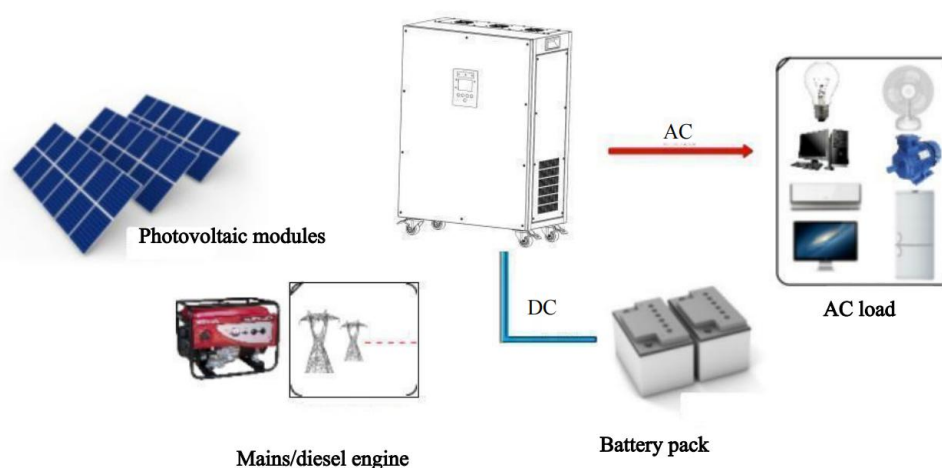

(3) In battery priority mode, when the photovoltaic panel does not generate electricity at night or on a cloudy or rainy day and the battery is low, the system works as shown in the figure below:

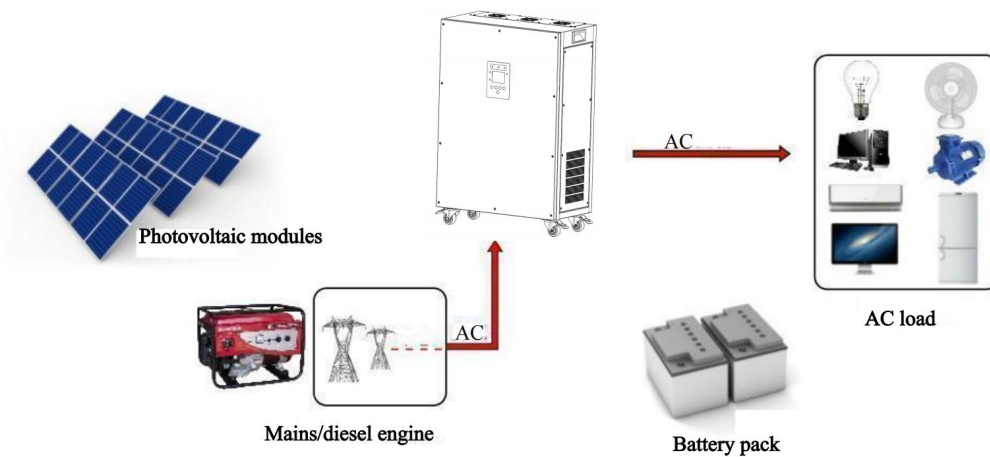

4.2.AC Priority:

When the mains (or diesel engine) input is normal, the inverter works in the mains bypass to supply power to the load and at the same time to the battery. When the mains power is too high/low/severe distortion/frequency abnormality/fault and other abnormal conditions, the inverter will automatically switch to the battery to supply power to the load. After the mains (or diesel engine) input is normal, the inverter will be reversed. The converter will automatically switch to the mains bypass to supply power to the load. This mode is suitable for the backup power system, the inverter is always on, and it is suitable for the unstable mains or the need to ensure the uninterrupted load to shorten the switching time.

(1) In the mains priority mode, when the photovoltaic panel is fully sunny and the mains input is normal, the system works as shown in the figure below:

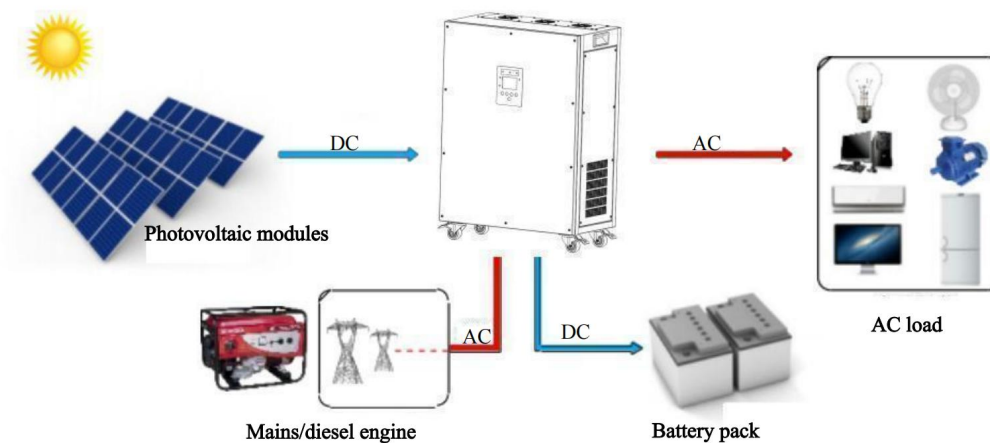

(2) In the mains priority mode, when the photovoltaic panel generates electricity with sufficient sunlight and the mains input is abnormal, the system works as shown in the figure below:

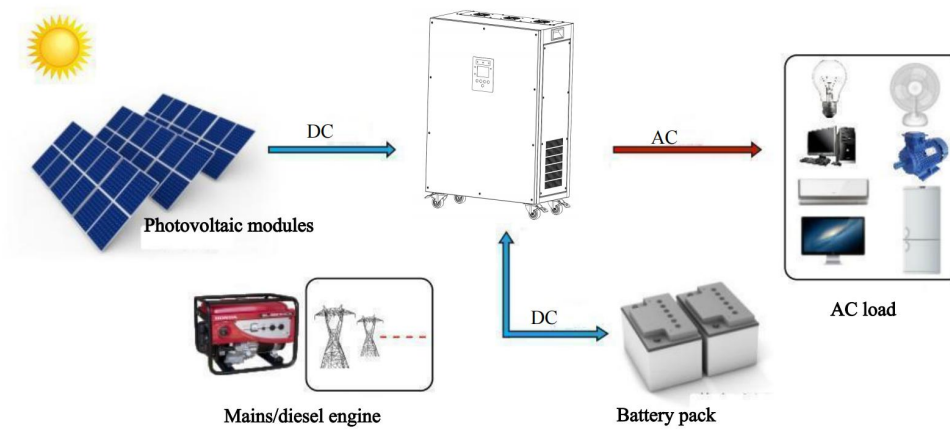

(3) In the mains priority mode, when the photovoltaic panel does not generate power at night or on a cloudy or rainy day and the mains input is normal, the system works as shown in the figure below:

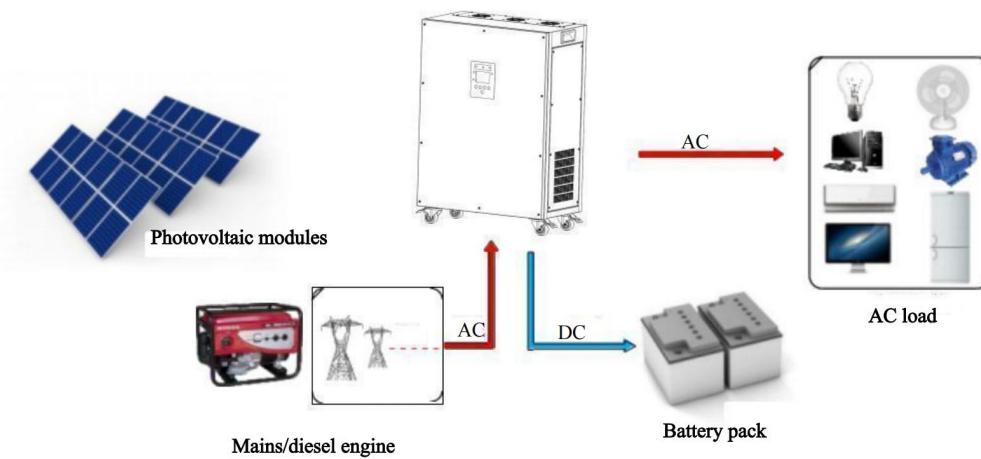

(4) In the mains priority mode, when the photovoltaic panel does not generate electricity at night or on a cloudy or rainy day, the mains input is abnormal and the battery voltage is normal, the system works as shown in the figure below:

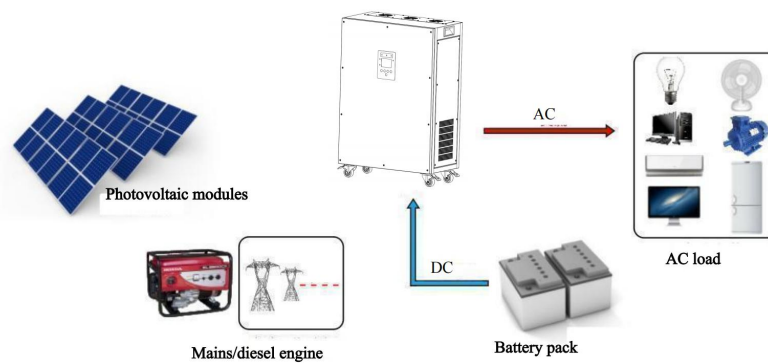

5.Appearance introduction

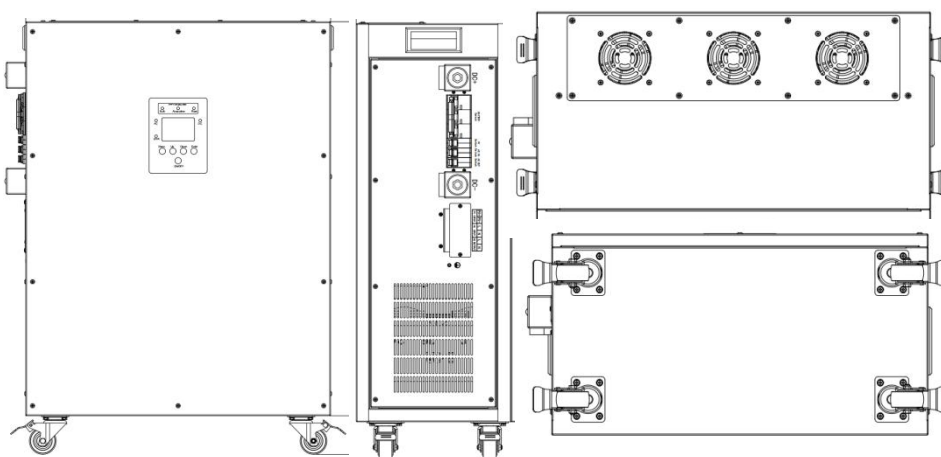

5.1 Terminal introduction

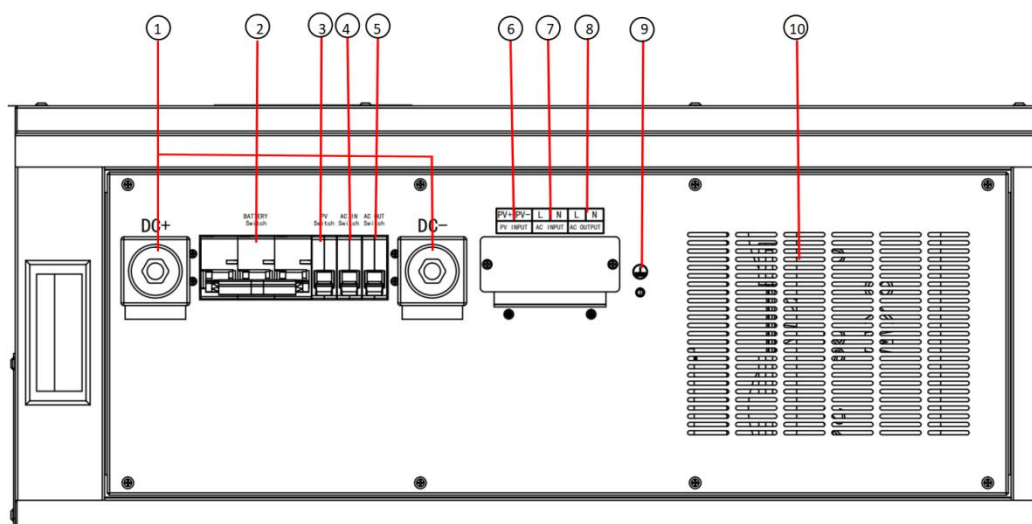

- ①DC is the battery input terminal, DC+ is the positive pole, and DC- is the negative pole;
- ②The battery switch must be disconnected before installation, and the switch can be turned on after the installation is complete;
- ③PV Switch is a photovoltaic input switch;
- ④AC IN Switch is an AC input switch, which needs to be disconnected before installation, and it can be turned on after the installation is complete;
- ⑤AC OUT Switch is an AC output switch, it needs to be disconnected before installation, and it can be turned on after the installation is completed;
- ⑥PV INPUT is the photovoltaic input terminal, + is the positive pole,-is the negative pole;
- ⑦AC INPUT is an AC input terminal, which can be connected to the mains for complementation, and it will not affect the use if it is not connected to the mains;
- ⑧AC OUT is an AC output port, which can be connected to a load;
- ⑨ is the ground terminal;
- ⑩Cooling fan;

6. Installation instructions

Please strictly follow the warnings and operating instructions in the manual and on the machine and keep this manual properly. Please do not operate this machine before reading all the safety instructions and operating instructions, otherwise it will damage the equipment and cause personal safety accidents.

6.1. Unpacking inspection

The inverter power supply has been strictly inspected before leaving the factory, but it may be damaged during transportation. Therefore, after unpacking, please check whether the following items are complete and whether the model, power, input voltage, output voltage, etc. are consistent with the order The specified content matches; if there is an abnormality or the content does not match, please contact our company as soon as possible.

6.2. Handling

This product should be handled with care during transportation to avoid falling, collision and strong vibration. It is strictly forbidden to turn the packaging box upside down. Do not lose accessories, instruction manuals, warranty cards, etc. when unpacking and transporting. In addition, this product is large and heavy. Please pay attention to safety when handling it to avoid injury to your body.

6.3. Installation instructions

1. When installing the inverter power supply, it must be done by professionals or with the assistance of local dealers.
2. Confirm whether the input DC power supply voltage range meets the requirements, ie +15%, and whether the power supply polarity is correct.
3. Confirm the voltage level of the load equipment, and the power should not be greater than the rated output power of the inverter power supply.
4. Do not pour liquid into the inverter power supply, or wipe the machine casing with a damp cloth. The human body cannot be directly when the machine is running
Touch the input and output terminals of the inverter power supply, especially with wet hands, otherwise it may cause electric shock.
5. If the working environment of the normal inverter power supply needs to be changed, it is not allowed to change its connection by yourself, and a professional should be
The operator or dealer confirms the operation.
6. The operating environment of the electric power supply should be in a well-ventilated environment with a temperature range of -25 to 50°C and a relative humidity of 30%-90%.
When using, keep it away from open flames and direct sunlight. No corrosive gas, oil mist, water splash, salt mist, rain, humidity, and can not operate in condensation and dust environment. If the altitude is below 1000m, please decide to use|great to use|data to use|drive to use|rate to use|dare to use|date to use|dream to use|rewrite to use|treat to use if it exceeds this altitude. A certain amount of heat is normal during use, but the installation environment must be kept clean and clean, especially not blocking the ventilation holes.
7. Minors are not allowed to use this product.
8. Confirm that the ground wire of the inverter power supply is reliably connected, the live wire and the neutral wire cannot be reversed, and the wire diameter should meet the conditions for safe use, The connection line should be as short as possible.
9. Please do not open the inverter power supply case by yourself, otherwise we will not be responsible for the warranty.
10. No objects can be placed on the top of the equipment; sufficient space for inspection and repair must be prepared directly in front of and above the equipment, and the power cord must be wired from the bottom of the machine;

Notice:

- A. This product cannot be used for life-sustaining equipment without permission.
- B. This inverter power supply is not suitable for ultra-high-precision electronic equipment, it needs to be confirmed by professional and technical personnel before it can be used
run.
- C. If it is used for computer load, the built-in power supply of the computer should be a brand
power supply.

warn!

It is strictly forbidden to connect the battery in reverse, and it is strictly prohibited to connect the live wire and the neutral wire in reverse.

It is strictly forbidden to use it in an environment with flammable and explosive gases, and beware of sparks!

The connection sequence must be the battery first and then the photovoltaic panel. It is strictly forbidden to reverse the sequence.

6.4. Safety instructions

1. Be sure to read the manual and understand all the contents before use.
2. Do not block the heat dissipation holes of the device with sundries during use to ensure good ventilation and heat dissipation.
3. Regardless of the working status, please do not remove or connect the equipment cable with power to avoid danger.
4. The connection cable must choose the appropriate specification, the connection is firm and the insulation is good.
5. Please do not close any circuit breakers before all equipment is fully connected
6. When inspecting or maintaining the inverter, you must wait for more than 10 minutes after removing the relevant connecting wires before opening the cover of the device to prevent the electric charge stored in the capacitor components of the inverter from causing electric shock to persons.
7. To avoid personal injury and machine damage caused by electric shock, do not open the cover (shell).
8. It is forbidden to connect the output of the inverter to the mains power grid. The mains line must be isolated from the inverter line before use, otherwise the inverter will be seriously damaged.
9. It is strictly forbidden to use it in an environment with flammable and explosive gases or objects, and beware of flames and sparks.
10. When the AC side of the inverter is loaded, the DC connection must not be directly disconnected. You must first cut off the DC switch of the inverter and confirm that there is no voltage before disconnecting the DC connection.
11. When the inverter is live, do not plug or unplug any connectors, and do not open the cover of the machine!
12. This equipment must not be operated with overload, and equipment failures and damages caused by overload operation are not covered by the warranty.

6.5 Wiring block connection attention:

Before the inverter is installed, disconnect all switches.

According to the picture above, AC INPUT is connected to the mains input (pay attention to the phase of zero live wire), G is grounding, AC OUTPUT is connected to load appliances (note the phase of zero live wire), SOLAR PANEL is connected to photovoltaic panels (note the positive and negative polarity), and BATTERY is connected to the battery (Pay attention to the positive and negative polarity), you need to connect the battery first and then the photovoltaic panel;

6.6 Wiring check

Connect all input and output wires, and check the following items:

Whether all the battery cables are connected correctly and in good contact, and the input, output, and grounding cables are correctly connected to the corresponding terminal block on the device.

6.7. Cable current-carrying capacity parameters: see the table below (subject to multi-strand copper core cables, unit: mm²)

Model	AC INPUT				DC INPUT		AC INPUT				PV		PE
	N	R	S	T	+	-	N	R	S	T	+	-	G
8KVA	10	10	10	10	25	25	10	10	10	10	10	10	6
10KVA	10	10	10	10	35	35	10	10	10	10	10	10	6
12KVA	16	16	16	16	40	40	16	16	16	16	10	10	10

7. Operation and maintenance

1. Connect and install the equipment in strict accordance with the relevant operating procedures. During installation, you should carefully check: whether the wire diameter meets the requirements; whether the components and terminals are loose during transportation; whether the insulation parts are well insulated; whether the grounding of the system meets the requirements.
2. It should be operated and used strictly in accordance with the provisions of the product instruction manual. Especially: Before starting the machine, pay attention to whether the input voltage is normal; when operating, pay attention to whether the sequence of power on and off is correct.
3. The equipment has automatic protection for short-circuit, over-current, over-voltage, over-heating, etc., so there is no need to shut down manually when these phenomena occur; the protection points for automatic protection are generally set at the factory and do not need to be adjusted.
4. There is high voltage in the equipment cabinet, and the operator is generally not allowed to open the cabinet door, and the cabinet door should be locked normally.
5. When the room temperature exceeds 50°C, heat dissipation and cooling measures should be taken to prevent the equipment from malfunctioning and prolong the service life of the equipment.
6. Regularly check whether the wiring of each part of the equipment is firm and whether there is any looseness. In particular, carefully check the fan, power module, input terminal, output terminal and grounding.
7. The operator must be specially trained to be able to judge the cause of the general failure and be able to eliminate it.
For example, you can skillfully replace fuses, components, and damaged circuit boards. Untrained personnel are not allowed to operate and use the equipment.
8. Once the alarm is stopped, it is not allowed to turn on immediately. The cause should be found out and repaired before turning on again.
9. If an accident that is not easy to eliminate or the cause of the accident is unclear, a detailed record of the accident should be made, and the production factory should be notified in time for resolution.
10. Virtual connection or damage to the battery pack is one of the main factors causing equipment failure. It is recommended to check the voltage of the battery and whether the connection terminals are reliably connected every two months (tools can be used to fasten each terminal), and remove the rust stains on the terminal in time. Clean the dust inside the equipment regularly, and disconnect the relevant connecting wires of the inverter during cleaning.
11. When the load is inductive loads such as refrigerators, motors, washing machines, water pumps, etc., the equipment should be selected at 5-6 times its nominal power, and the load should be increased one by one. Frequent starting is strictly prohibited.
12. When the inverter fails to work normally, please refer to the instructions in the manual. If it still cannot be solved, please contact the dealer or the manufacturer as soon as possible. Do not disassemble the parts by yourself!

8. Start-up procedure of the inverter control integrated machine:

Correctly operating the inverter power supply can better ensure its service life and provide high-quality input power for your load equipment. The following are the recommended normal operation steps of inverter power supply for you.

8.1. Normal start-up steps of the inverter power supply

1. Connect the front AC input power;
2. Close the inverter DC input switch (battery switch);
3. After the inverter output indicator INV lights up, close the inverter AC input switch;
4. After confirming that the load can be powered, close the inverter AC output switch;
5. Turn on the load equipment switches one by one;

8.2. Operation steps for normal shutdown of inverter power supply

1. Turn off the load equipment switches one by one;
2. Disconnect the AC output switch of the inverter power supply;
3. Disconnect the AC input switch of the inverter power supply;
4. Disconnect the inverter DC input switch (battery switch);
5. Disconnect the front-level AC input power;

9. Emergency shutdown procedure:

This operating procedure can only be operated when fire, electric shock, arc or other hazards occur, but it will cause no danger of AC output.

—— Disconnect all switches downward

Notice:

The company reserves the right not to guarantee the quality of the products in the following situations.

1. The whole machine and parts have exceeded the free warranty period;
2. Product transportation damage;
3. Incorrect installation, modification or use that is not in accordance with the requirements of the manual;
4. Exceed the very harsh environment described in this manual;
5. Failure or damage to the machine caused by installation, repair, modification or disassembly by non-service agencies or personnel of our company.

If the product fails due to the above situation, the customer requires maintenance service. After the judgment of the company's service department, paid maintenance services can be provided.

10. Operation interface description:

10.1 Open the main interface

The operation control display panel is located on the front. By operating the control display panel, you can control and query all parameters, battery status, and alarm information. This series of inverters can choose whether to need MPPT. The interface with MPPT is shown in Figure 3-1, and the interface without MPPT is shown in Figure 3-2. The following instructions are introduced in accordance with Figure 1, as shown in Figure 3-1. The operation control display panel can be divided into three parts according to functions: MPPT light display, LCD display and menu keys, and control operation keys. The description of the components of the operation control display panel is shown in Table 10-1.

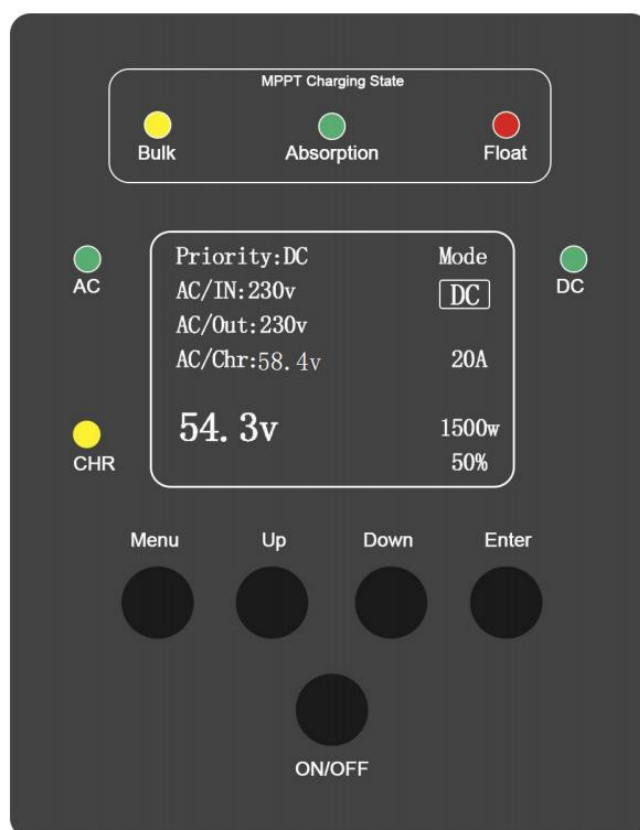

Figure 10-1 Operation Control Display Panel (with MPPT)

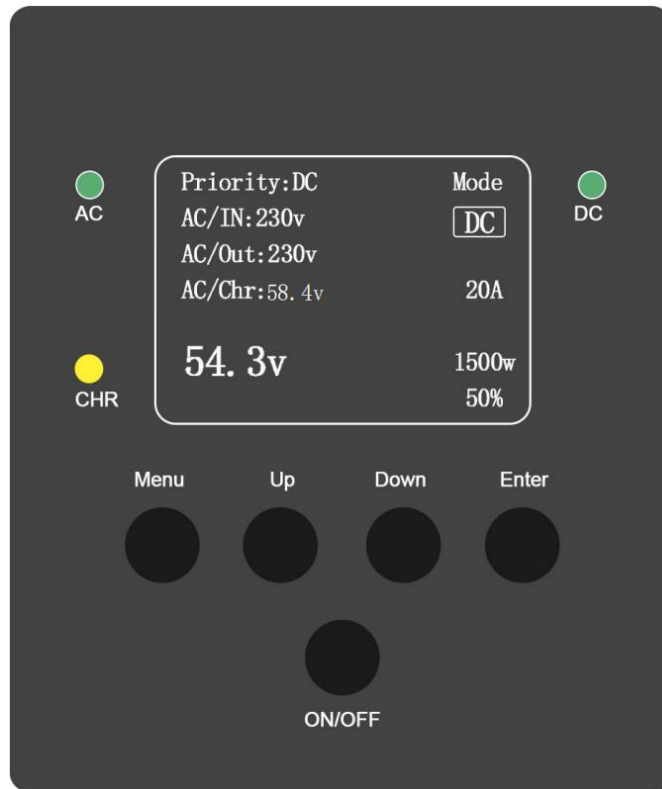

Figure 10-2 Operation Control Display Panel (without MPPT)

Table 10-1 Description of the operation control display panel components

explicit identification	description	explicit identification	description
Priority	Current priority mode	54.3v	Current battery voltage
AC/IN	AC input value	DC	Current output mode
AC/Out	AC output value	1500w 50%	Current power and load percentage

Note: The above values are the demonstration values, for reference only

Table 10-2 Key press description:

Key identification	meaning
MENU	Enter the menu
UP	Select up
DOWN	Select down
ENT	Determine or return
ON/OFF	Turn on or turn off, Press the on / off button for 5 seconds.

10.2 LED indicator lamp

Table 10-3 Description of the indicator lamp status

pilot lamp	state	meaning
AC	The yellow is often bright	The machine is running and in the main power output mode
	The yellow is not bright	

pilot lamp	state	meaning
DC/INV	Green is often bright	Battery inverter running in the state of the machine, from the battery inverter power output
	Green, not bright	
CHR	light on	The equipment is charged via the main power supply
MPPT Charging State		
Bulk	light on	In fast charge mode
	light off	Not under fast charge
Absorption	light on	In equal charge mode
	light off	Not in equal charge mode
Float	light on	In float mode
	light off	Not in floating charge mode

10.3 Sound alarm (buzzer)

Operation can be accompanied by two different sound alarms as described in Tables 3-4.

Table 10-4 Sound alarm description

alarm call	meaning
Continue to cry	Power boot self-inspection
Two short sounds	Set the save
A short sound	key

10.3 System settings

(1) Settings: Home-Menu-Enter the System Settings page, select needs and enter by pressing up and down.

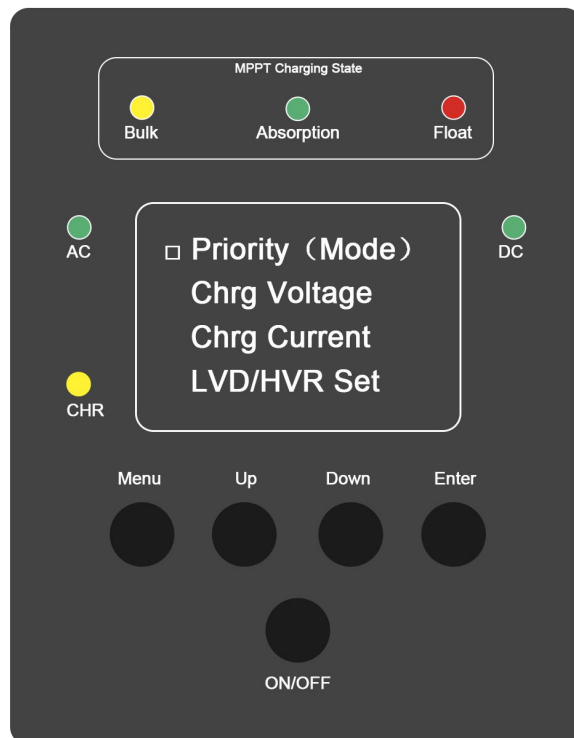

(2) Priority (Mode) settings: Press up and down to select the mode and enter, and then the machine will restart and run the new mode.

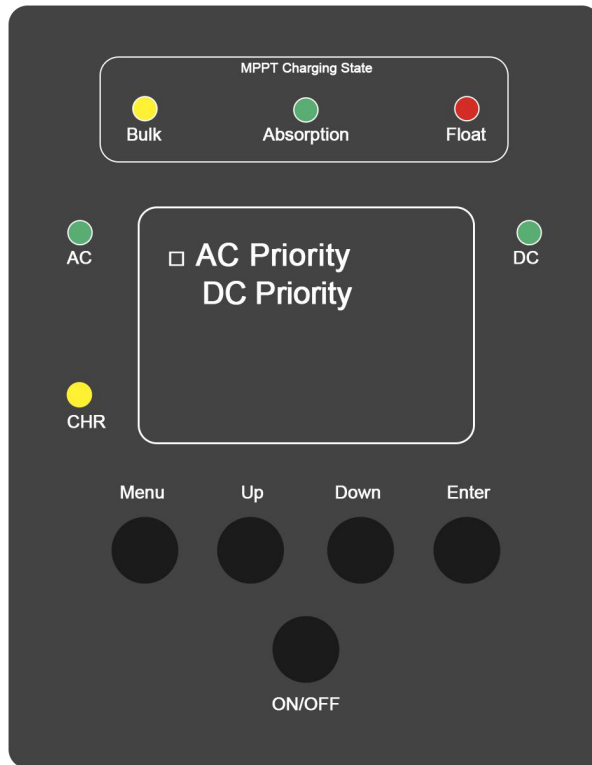

(3) AC charging voltage setting: Press up and down, which will display in the lower left corner,

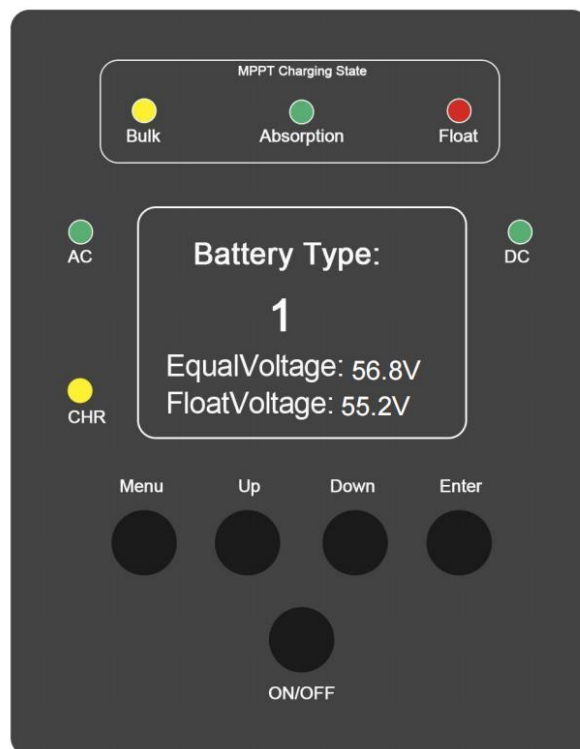

(4) AC charging current setting: press up and down to select the charging current. Choosing an OA means that charging stops automatically after charging. Press Enter to confirm, and the machine will restart.

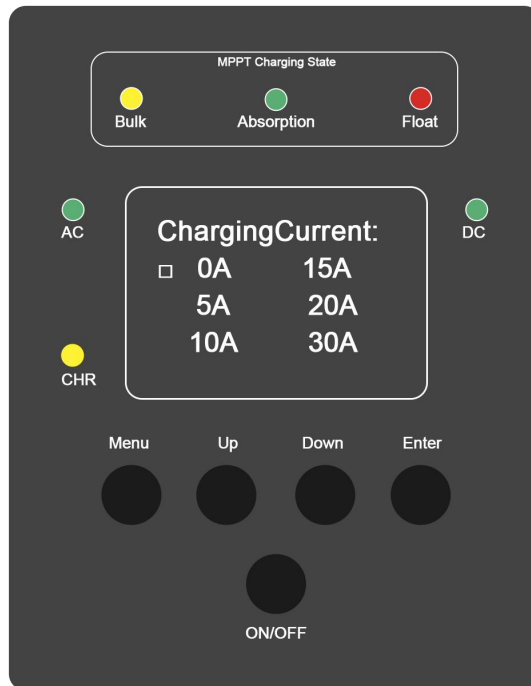

(5) DC priority mode instruction: (battery high voltage automatically changed to inverter, low voltage to power supply).
 In this mode, the inverter preferentially uses a DC power supply (battery), when the battery power is fully charged by the total or solar power,
 Turning to the user setting the HVR, the inverter automatically becomes an inverted output. When the low power sets the LVD as the user,
 Working mode changes to the power output. Press the upper and lower keys to select the voltage, and the menu sets the HVR and LVD. Then press Enter to confirm, and the machine will restart and run the new mode.

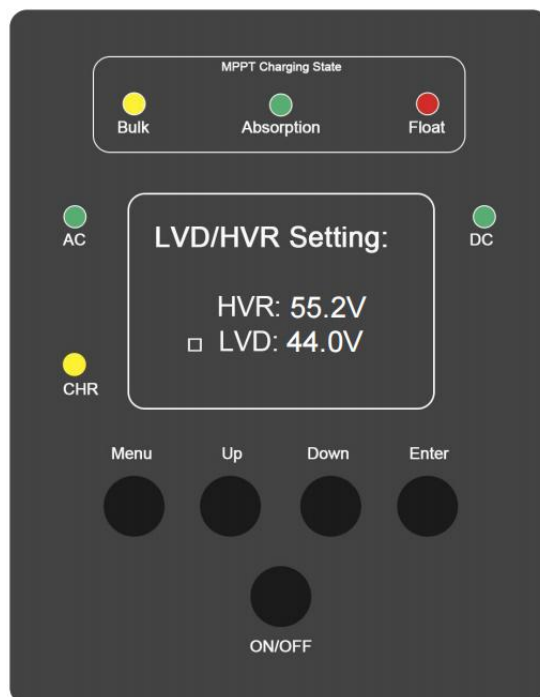

(6) MPPT charging current setting
 Refer to the AC charging settings.

11.technical parameter

Technical Parameter :			
Inverter Mode	8KVA OGM	10KVA OGM	12KVA OGM
Rated power	6KW	8KW	10KW
Battery voltage	48V		
Chassis size (W * D* Hmm)	580*370*730	740*400*930	
Package size(W * D *Hmm)	650*420*840	820*480*1050	
Net weight(kg)	65	85	95
Gross weight(kg)	80	100	110
Input			
Phase	L+N+G		
Mains input range	110V:85~138VAC;220V:170~275VAC		
Frequency Range	45Hz~65Hz		
Output			
Output voltage	Inverter mode: 110VAC/220V±5%; Mains mode: 110VAC/220VAC±10%;		
Frequency range(Mains mode)	Automatic tracking		
Frequency range(inverter mode)	50Hz/60Hz±1%		
Over load (Mains mode)	Mains mode: (100%~110%: 10 minutes; 110%~130%: 1 minute; >130%: 1 second;)		
Over load(inverter mode)	Inverter mode: (110%~110%: 30 seconds; 110%~130%: 10 seconds; >130%: 1 second;)		
Current peak ratio	3:1max		
Switching time	<10ms (typical load)		
Wave	Pure sine wave		
Efficient	>85% (80% resistive load)		
Protective function	Battery over voltage and low voltage protection, overload protection, short circuit protection, over temperature protection, etc.		
Built-in solar controller (optional)			
Maximum charging current	100A	150A	
Battery voltage	48V		
PV input voltage range	65V ~250V		
Maximum photovoltaic input power	4800W	7200W	
Cooling method	Air-cooled		
Environmental conditions			
Operating temperature	0~40℃ (battery life will be shortened in an environment >25℃)		
Operating humidity	<95% and no condensation		
Operating altitude	<1000m (1% per 100 m, up to 5000 m)		
Noise	<58dB (1 meter distance)		
Manage			
show	LCD+LED		
Computer communication interface	RS232 (optional)		
* The above data is for reference, if there is any change, please refer to the actual product.			

12. The causes and treatment methods of common failures:

Since the inverter itself has complete protection functions, once an abnormality or failure occurs, the inverter will be shut down or the output will be stopped, and the LCD display will indicate the corresponding abnormal information and the working status of the inverter respectively.

Failure phenomenon	cause of issue	Approach
In the absence of AC input, the inverter cannot start	DC input abnormal	Check whether the connecting wire of the DC (battery) input is connected correctly, with good contact and correct polarity, and measure whether the voltage between the two terminals of the DC (battery) input is normal.
	DC input switch is open	Check the DC input switch
	Output overload or short circuit	Turn off the load and check whether the load cable is damaged or short-circuited
AC input failed	Abnormal AC input	Check whether the AC input cable is connected correctly, in good contact and the phase is correct, and measure whether the AC input voltage and frequency are normal.
	AC input switch is open	Check the AC input switch
Without AC input, the machine has no AC output	AC output switch is open	Check the AC output switch
	DC input over voltage	Discharge the battery to a normal value and then reconnect and boot
	DC input under voltage	Wait for the photovoltaic module to charge the battery to the normal value, or switch the mains priority mode to charge the battery to the normal value, then the output can be restored
	Output overload or short circuit	Turn off the load and check whether the load cable is damaged or short-circuited
Machine high temperature alarm	The internal temperature of the machine is too high	Check whether the fan is faulty and whether the cooling holes are blocked
Machine overload alarm	Load power exceeds rated value	Remove non-critical loads

When the inverter fails to work normally, please refer to the instructions in the manual. If it still cannot be solved, please contact the dealer or the manufacturer as soon as possible. Do not disassemble the parts by yourself!

13.Packing list:

Number	Name	Quantity/Unit	Remark
1	Inverter host	1 set	
2	user's manual	1 copy	
3	Warranty Card	1 piece	

If the user cannot understand the contents of the manual or wants more detailed help when using it, please contact the dealer or consult our company, we will be happy to serve you.



PSC Solar UK

Physical Office/Warehouse: 41B, Olutoye Cres/Adeniyi Jones, Ikeja, Lagos State, Nigeria

Phone No.: +2348120855444, +2348123655444

Website: www.pscsolaruk.com Email Address: info@pscsolaruk.com

Error code	Fault code description	Maintenance instructions
1	Low voltage of battery	Check external batteries
2	Output short circuit	Disconnect the load and check the AC output line and load
3	Output high and low voltage	Disconnect the load and check whether the alarm persists when there is no load. If there is a need to repair the main-board, check whether there is no load
4	Overload	Disconnect the load and check the AC output line and load
5	Overheat	Check whether the machine fan is damaged or the temperature control cable
6	Manual shutdown	Check whether the switch button is unpressed
7	Fan failure	Check whether the machine fan is damaged
8	Output Current Excessive Shutdown	Disconnect the load and check whether the AC output line and load are short-circuited or overloaded
9	DC high voltage	Check the battery voltage and bus capacitance
10	Manual restart	Indicates that the machine has manual press on/off button restart operation
11	Input abnormal (battery voltage is incorrect)	Check whether the external battery has a high or low voltage
12	Abnormal voltage reference	Check the battery voltage detection circuit on the main-board
13	Driver board protection	Check the driving circuit and the corresponding power tube
14	Standby energy saving	The machine is in energy-saving standby mode
15	Battery priority, no mains standby after low voltage transfer to mains	Check whether the battery voltage and AC input are normal
17	Battery high temperature protection	Check external batteries
18	Overheating The radiator is normally closed at 80 degrees	The same with 5
19	Bus current software protection	Restart the machine. If the fault persists, replace the main-board
20	Bus current hardware protection	Restart the machine. If the fault persists, replace the main-board

1. Overview

This protocol is used for the communication between the company's inverter and the background PC software. The protocol refers to the implementation of MODBUS standard on TCP/IP, and improves the communication mechanism and communication management.

1.1. References

GB/T 19582-1 2008 《Industrial automation network Specification based on Modbus protocol -- Part 1: Modbus application protocol》

GB/T 19582-2 2008 《Specification for industrial automation networks based on Modbus protocol -- Part 3: Guidelines for Modbus protocol implementation over serial links》

1.2. Abbreviations

UPS: uninterruptible power supply system

EPS: Emergency power supply system

INV: inverter

2. Communication mode

2.1. Physical layer interfaces

RS485 communication. Baud rate 9600bps, 1 start bit, 1 stop bit, 2 bit CRC verification.

2.2. Communication mechanism

The device adopts serial MODBUS RTU communication mode, and the device serves as a service (slave).

3. Information type and structure

3.1. Data types

Table 3-1 Data type table

Data types	Symbol	Describe
8bit Unsigned integer	BYTE	0~255
16bit Unsigned integer	UINT16	0~65535
16bit Signed integer	INT16	-32768~32767
32bit Floating-point	FLOAT	IEEE754
32bit Unsigned integer	UINT32	
32bit Signed integer	INT32	
64bit Unsigned integer	UINT64	
64bit Signed integer	INT64	
[N Byte] String	String[N]	
[N Byte] An array of bytes	BYTEA[N]	
BOOL	BOOL	There are only 0 and 1 states. Used only for discrete input registers.

3.2. Command structure

Table 3-2 Command structure table

Types	The number of bytes	Describe
Address	1	BYTE data, the address of the object. The range of 0 ~ 247. 0 indicates the broadcast address. 247 is a generic point-to-point communication address (applicable only to point-to-point communication links).
Function Code	1	BYTE data. See command parsing. In normal cases, the sending and replying codes are the same. In abnormal cases, see "Abnormal Reply Mechanism".
Data	N	See Command parsing.
Check	2	It adopts MODBUS CRC16 verification, and the high byte is the first

3.3. Data storage and transmission sequence

3.3.1 16-bit integer type byte storage and transfer order

For 16-bit integers, transfer high bytes, then low bytes. For example, 3A56H, transmit 3AH and then 56H.

Both the input and hold registers are 16bit addressed registers. It can be considered that the bit storage order of a single register is also high byte first and low sub byte after.

3.3.2 32-bit integer type word storage and transfer order

For 32-bit integers, transfer low 16bit high, then 16bit high. For example, 8DF377A2H data, first transmit 77A2H, and then transmit 8DF3H.

3.3.3 Floating-point number storage and transmission sequence

Floating point number adopts IEEE32 bit standard floating point number format (standard C format), 32bits in length, storage format of four bytes, as shown in the table below.

D31	D30-D23	D22-D16	D15-D8	D7-D0
Floating point number symbol 'S'	the order code	The end of the high	The end of the median	The end of the low

If the order code is E and the mantissa is M, the floating point value = $\pm (1 + M 2^{-23}) 2^{E-127}$

The positive and negative floating point number depends on the value of the symbol bit S, S=1 means that the floating point number is negative, and S=0 means that the floating point number is positive.

For example, when the 32-bit floating point number is 40H, A0H, 00H, 00H, namely S=0, E=81H=129, M=200000H=221: Floating-point value = $(1 + 221 \cdot 2^{-23}) 2^{129-127} = 5.0$.

When sending, send 4 bytes in the order of symbol bit and order code, mantissa high, mantissa median and mantissa low.

4. Command parsing

Only the 03H and 06H function codes are used for this protocol.

4.1 Read the hold register '03H'

This protocol 03 function code starts at address 0.

Host command format:

Definitio on	Address	Function code	Register start address	Number of registers	CRC verification
Data	ADDR	03H	sREG	nREG	CRC 16
Bytes	1	1	2	2	2

From the machine response format:

Definitio on	Address	Function code	Register start address	Number of registers	CRC verification
Data	ADDR	03H	X	DATA	CRC 16
Bytes	1	1	1	X	2

4.2. Write a single hold register of '06H'

This protocol 06 function code starts at address 100.

Host command format:

Definitio on	Address	Function code	Register start address	Number of registers	CRC verification
Data	ADDR	06H	sREG	DATA	CRC 16
Bytes	1	1	2	2	2

From the machine response format:

Definitio on	Address	Function code	Register start address	Number of registers	CRC verification
Data	ADDR	06H	sREG	DATA	CRC 16
Bytes	1	1	2	2	2

5. Register definition

5.1 '03' Functional code to read the information quantity

Register definition

Register address	Register name	data type	read-w rite	unit	coeffi cient	instruction
0	Used voltage	UINT16	R	V	0.1	Grid Voltage
01	Output voltage	UINT16	R	V	0.1	Inverter output voltage
02	Grid frequency	UINT16	R	HZ	0.1	
03	Inverter output	UINT16	R	HZ	0.1	

	frequency					
04	Inverter output power	UINT16	R	W	1	
05	Output the load ratio	UINT16	R	%	1	
06	Battery type	UINT16	R		1	0=铅酸电池。1=锂电。2=用户自定义
07	Battery voltage value	UINT16	R	V	0.1	
08	Grid charging current	UINT16	R	A	0.1	
09	The inveter operating temperature	UINT16	R	C	1	
10	Bulk voltage	UINT16	R	V	0.1	The average charge voltage of Grid
11	Floating voltage	UINT16	R	V	0.1	Grid floating charging voltage
12	MPPT input voltage	UINT16	R	V	1	MPPT input voltage
13	MPPT input current on	UINT16	R	A	1	MPPT input current on
14	MPPT interior input power	UINT16	R	W	1	MPPT interior input power
15	MPPT output current	UINT16	R	A	1	MPPT output current
16	MPPT running temperature	UINT16	R	C	1	MPPT module running temperature
17	MPPT floating charge voltage value	UINT16	R	V	0.1	MPPT floating charge voltage value
18	MPPT all-charge voltage value	UINT16	R	V	0.1	MPPT all-charge voltage value
19	MPPT fault code	UINT16	R		1	MPPT fault code
20	MPPT charging status code	UINT16	R		1	0 = Stop the charging. 1= Fast charging mode. 2= All charge mode. 3= Floating charge mode. 4= In the M P P T tracking. 5= Flow-limiting mode.
21	Inverter operating state	UINT16	R		1	0= Grid power output, 1= battery inverter output
22	Inverter operating mode	UINT16	R		1	0= Grid priority. 1= Battery priority
23	Inverter fault	UINT16	R		1	

	code					
24	The inverter charging status code	UINT16	R		1	0= Stop the charging. 1= Fast charging mode. 2= Mean charging mode. 3= Floating charging mode
25	low-voltage protection value	UINT16	R	V	0.1	Inverter low-voltage protection value
26	Inverter HVR value	UINT16	R	V	0.1	When the battery voltage recovers the HVR value from the low voltage, turn to the inverter output
27	Inverter LVD1	UINT16	R	V	0.1	When battery priority mode, if the battery voltage drops to LVD1, the machine switches to the Grid output
28	Inverter LVD2	UINT16	R	V	0.1	When battery priority mode, if the battery voltage drops to LVD2 and there is no power grid input, the machine cut off.
29	Inverter low-voltage alarm value	UINT16	R	V	0.1	
30	Inverter high-voltage protection value	UINT16	R	V	0.1	
31	Inverter high-voltage alarm value	UINT16	R	V	0.1	
32	Inverter high pressure recovery value	UINT16	R	V	0.1	
33	Inverter low-voltage recovery value	UINT16	R	V	0.1	
34	Inverter low-voltage alarm value	UINT16	R	V	0.1	
35	Inverter low voltage shutdown system	UINT16	R	V	0.1	

5.2 '06' Functional code to write the information quantity(set up parameters)

Register address	Register name	data type	read-write	unit	coefficient	instruction
100	Save the parameters	UINT16	W			Write to 0xbe and save the parameters
101	Set priority mode	UINT16	W			Write 0x01 set AC priority. Write 0x02 set DC priority
102	Set the average charging voltage	UINT16	W	V	0.1	
103	Set the floating charge voltage	UINT16	W	V	0.1	
104	Set Grid max Charging current	UINT16	W	A	0.1	0= Turn off the charge. 1=5A, 2=10A, 3=15A, 4=20A
105	Set the HVR value	UINT16	W	V	0.1	
106	Set the LVD1 value	UINT16	W	V	0.1	
107	Set the LVD2 value	UINT16	W	V	0.1	
108	obligate	UINT16				
109	Turn off the buzzer	UINT16	W			1; = Silencing.2; = Restore the alarm
110	Battery high-voltage protection value	UINT16	W	V	0.1	
111	Battery high-voltage recovery value	UINT16	W	V	0.1	
112	Battery high-voltage alarm value	UINT16	W	V	0.1	
113	Battery low-voltage recovery value	UINT16	W	V	0.1	
114	Battery low-voltage alarm value	UINT16	W	V	0.1	
115	turn off the machine	UINT16	W			Write the power off, after you need to manually open

5.3 Inverter fault code:

Error code	Fault code description	Maintenance instructions
Error code	Fault code description	Maintenance instructions
1	Low voltage of battery	Check external batteries
1	Charging voltage is high voltage	Check external batteries
2	Output short circuit	Disconnect the load and check the AC output line and load
2	Output short circuit	Disconnect the load and check the AC output line and load
3	Output high and low voltage	Disconnect the load and check whether the alarm persists when there is no load. If there is a need to repair the mainboard, check whether there is no load
4	Overload	Disconnect the load and check the AC output line and load
5	Overheat	Check whether the machine fan is damaged or the temperature control cable
6	Manual shutdown	Check whether the switch button is unpressed
7	Fan failure	Check whether the machine fan is damaged
8	Output Current Excessive Shutdown	Disconnect the load and check whether the AC output line and load are short-circuited or overloaded
9	DC high voltage	Check the battery voltage and bus capacitance
10	Manual restart	Indicates that the machine has manual press on/off button restart operation
11	Input abnormal (battery voltage is incorrect)	Check whether the external battery has a high or low voltage
12	Abnormal voltage reference	Check the battery voltage detection circuit on the mainboard
13	Driver board protection	Check the driving circuit and the corresponding power tube
14	Standby energy saving	The machine is in energy-saving standby mode
15	Battery priority, no mains standby after low voltage transfer to mains	Check whether the battery voltage and AC input are normal
17	Battery high temperature protection	Check external batteries
18	Overheating The radiator is normally closed at 80 degrees	With 5
19	Bus current software protection	Restart the machine. If the fault persists, replace the mainboard
20	Bus current hardware protection	Restart the machine. If the fault persists, replace the mainboard

5.4			AC output line and load	MPPT
	3	PV input overvoltage	Disconnect the load and check whether the alarm persists when there is no load. If there is a need to repair the mainboard, check whether there is no load	
	4	Pv input is low voltage	Disconnect the load and check the AC output line and load	
	5	Overheat	Check whether the machine fan is damaged or the temperature control cable	
	6	Input and output voltage difference protection	Check whether the switch button is unpressed	
	7	MOS pipe over temperature protection		
	8	Hardware over-current protection		
	9	system reset		
	10	The output voltage is too high		
	11	The output voltage is too low		

Controller Fault Code:

Note: This version needs to remotely control the inverter to turn off, and write the 06 function code to the register 115 with a shutdown value to make the machine shut down. Do not write the save settings in register 100.
