



Off Grid Solar Inverter SPF 3000T HVM-G2

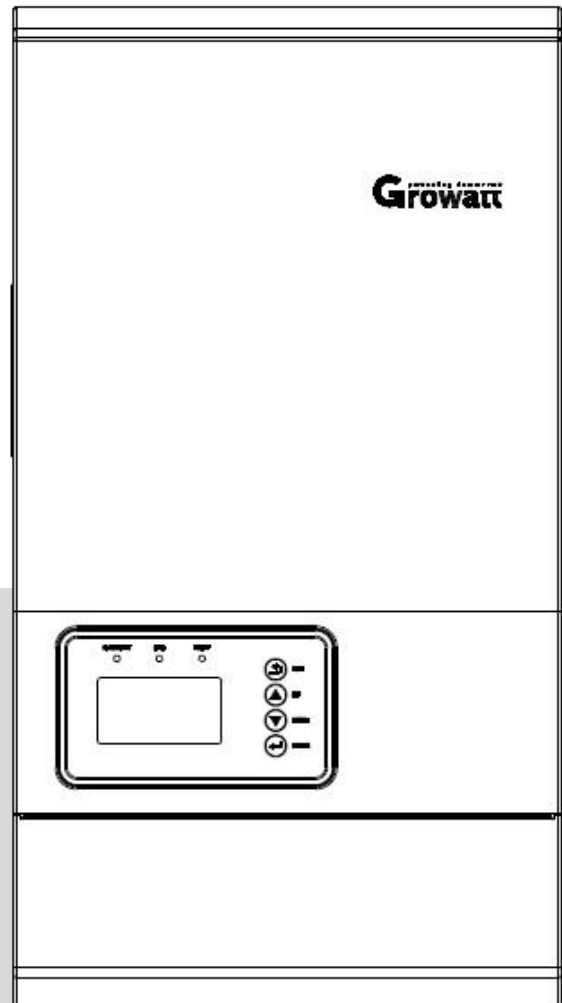

Table Of Contents

Information on this Manual	1
Validity.....	1
Scope.....	1
Target Group.....	1
Safety Instructions.....	1
Introduction	2
Features.....	2
Product Overview.....	3
Installation	4
Unpacking and Inspection.....	4
Mounting the Unit.....	4
Battery Connection.....	5
AC Input/Output Connection.....	8
PV Connection.....	10
Communication Connection.....	11
Dry Contact Signal.....	11
Battery Charger	12
Battery Equalization	13
Operation	14
Power ON/OFF.....	14
Operation and Display Panel.....	14
Display Information.....	21
Operating Mode Description.....	22
Fault Code	23
Warning Code	23
Trouble Shooting	24
Specifications	25

Information on this Manual

Validity

This manual is valid for the following devices:

- ▶ SPF 3000T HVM-G2

Scope

This manual describes the assembly, installation, operation and troubleshooting of this unit. Please read this manual carefully before installations and operations.

Target Group

This document is intended for qualified persons and end users. Tasks that do not require any particular qualification can also be performed by end users. Qualified persons must have the following skills:

- ▶ Knowledge of how an inverter works and is operated
- ▶ Training in how to deal with the dangers and risks associated with installing and using electrical devices and installations
- ▶ Training in the installation and commissioning of electrical devices and installations
- ▶ Knowledge of the applicable standards and directives
- ▶ Knowledge of and compliance with this document and all safety information

Safety Instructions



WARNING: This chapter contains important safety and operating instructions. Read and keep this manual for future reference.

1. Please be clear which kind of battery system you want, lithium battery system or lead-acid battery system, if you choose the wrong system, energy storage system can't work normally.
2. Before using the unit, read all instructions and cautionary marking on the unit, the batteries and all appropriate sections of this manual. The company has the right not to quality assurance, if not according to the instructions of this manual for installation and cause equipment damage.
3. All the operation and connection please professional electrical or mechanical engineer.
4. All the electrical installation must comply with the local electrical safety standards.
5. When install PV modules in the daytime, installer should cover the PV modules by opaque materials, otherwise it will be dangerous as high terminal voltage of modules in the sunshine.
6. **CAUTION**-To reduce risk of injury, charge only deep-cycle lead-acid type rechargeable batteries and lithium batteries. Other types of batteries may burst, causing personal injury and damage.
7. Do not disassemble the unit. Take it to a qualified service center when service or repair is required. Incorrect re-assembly may result in a risk of electric shock or fire.
8. To reduce risk of electric shock, disconnect all wirings before attempting any maintenance or cleaning. Turning off the unit will not reduce this risk.
9. **NEVER** charge a frozen battery.
10. For optimum operation of this inverter, please follow required spec to select appropriate cable size. It's very important to correctly operate this inverter.
11. Be very cautious when working with metal tools on or around batteries. A potential risk exists to drop a tool to spark or short circuit batteries or other electrical parts and could cause an explosion.
12. Please strictly follow installation procedure when you want to disconnect AC or DC terminals. Please refer to INSTALLATION section of this manual for the details.
13. **GROUNDING INSTRUCTIONS** -This inverter should be connected to a permanent grounded wiring system. Be sure to comply with local requirements and regulation to install this inverter.
14. **NEVER** cause AC output and DC input short circuited. Do NOT connect to the mains when DC input short circuits.
15. Make sure the inverter is completely assembled, before the operation.

Introduction

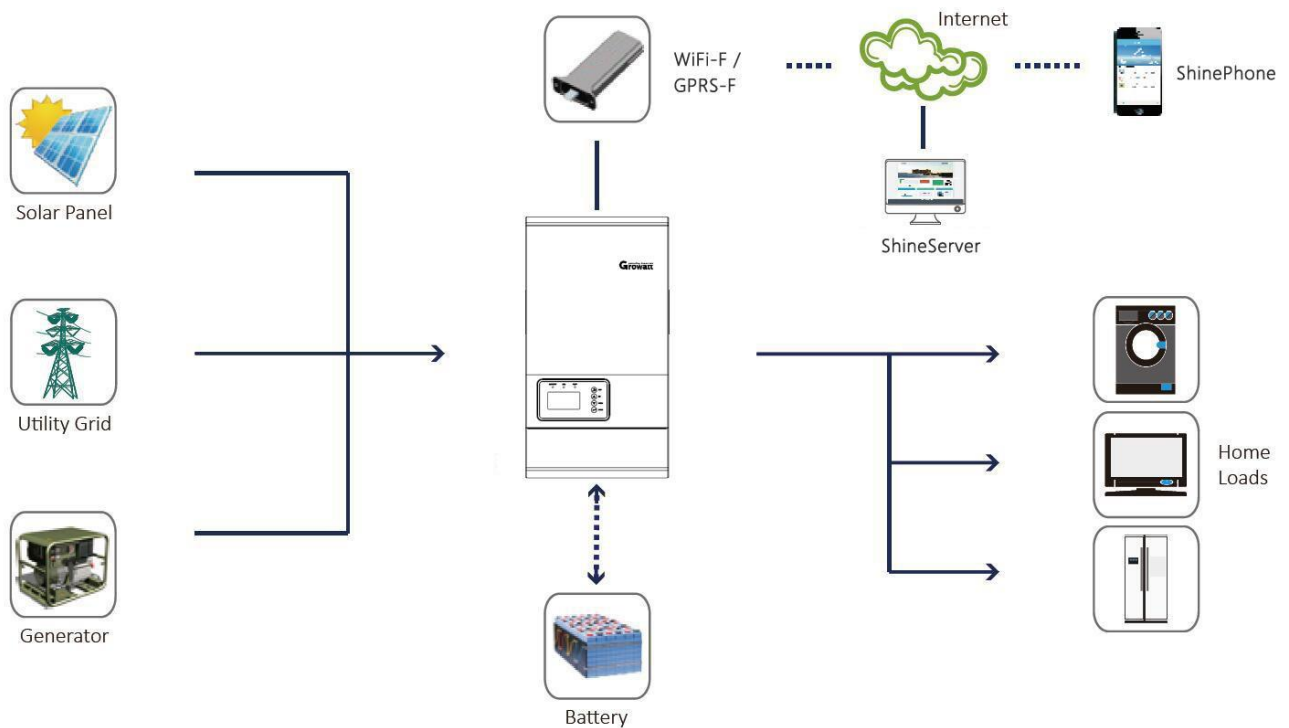

Hybrid Power System

This is a multifunctional off grid solar inverter, integrated with a MPPT solar charge controller, a low frequency pure sine wave inverter and a UPS function module in one machine, which is perfect for off grid backup power and self-consumption applications. This inverter can work with or without batteries.

The whole system also need other devices to achieve complete running such as PV modules, generator, or utility grid. Please consult with your system integrator for other possible system architectures depending on your requirements. The WiFi / GPRS module is a plug-and-play monitoring device to be installed on the inverter. With this device, users can monitor the status of the PV system from the mobile phone or from the website anytime anywhere.

Features

- ▶ Rated power 3KW, power factor 1
- ▶ PV input voltage ranges 60~250Vdc
- ▶ Low frequency inverter with large transformer
- ▶ Pure sine wave AC output
- ▶ Solar and utility grid can power loads at the same time
- ▶ With CAN/RS485 for BMS communication
- ▶ System will go to bypass and cut off charging if an error happens under utility grid mode
- ▶ With the ability to work without battery (only under utility grid mode)
- ▶ WiFi/ GPRS remote monitoring (optional)

Product Overview

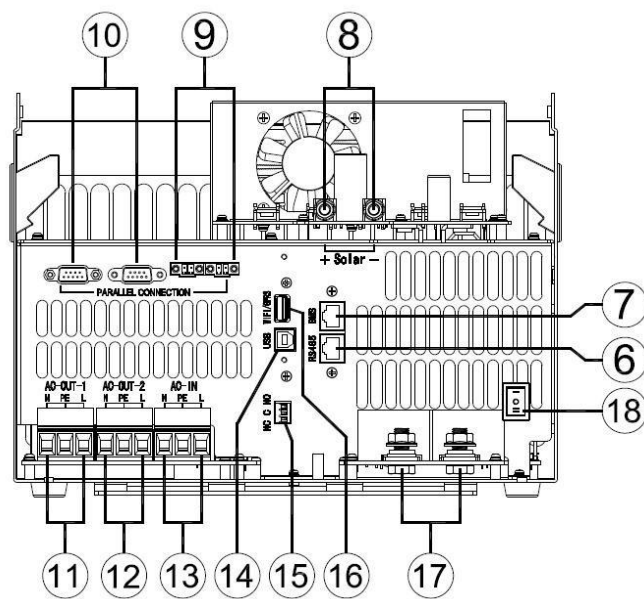
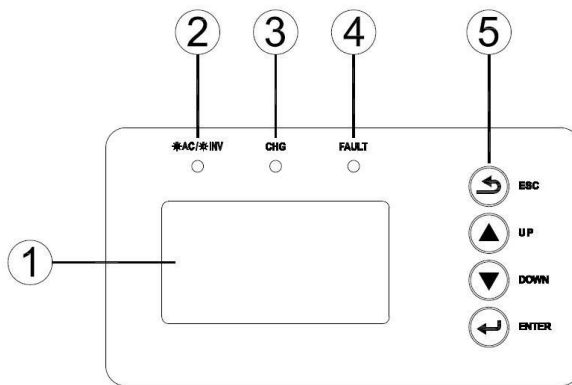
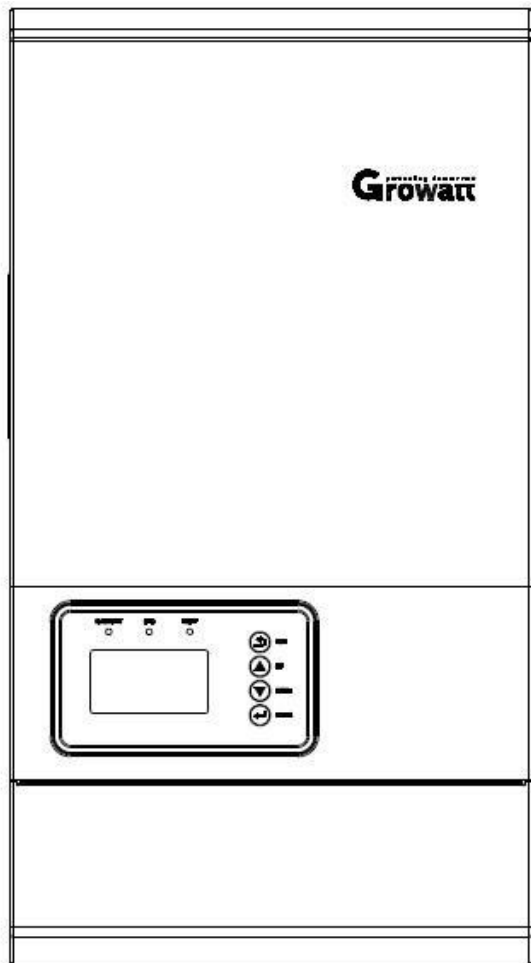

- 1. LCD display
- 3. Charging indicator
- 5. Function buttons
- 7. BMS communication Port
- 9. Current sharing ports
- 11. AC output 1
- 13.AC input
- 15. Dry contact
- 17. Battery input

- 2. Status indicator
- 4. Fault indicator
- 6. RS485 communication Port
- 8. PV input
- 10. Parallel communication ports
- 12. AC output 2
- 14. USB communication port
- 16. WiFi/GPRS communication port
- 18. Power on/off switch

Installation

Unpacking and Inspection

Before installation, please inspect the unit. Be sure that nothing inside the package is damaged. You should have received the following items in the package:

- ▶ The unit x 1
- ▶ User manual x 1
- ▶ Communication cable x 1
- ▶ Software CD x 1
- ▶ Screws x 3
- ▶ Mounting board x 1

Preparation

Before connecting all wiring, please take off bottom cover by removing four screws as shown below.

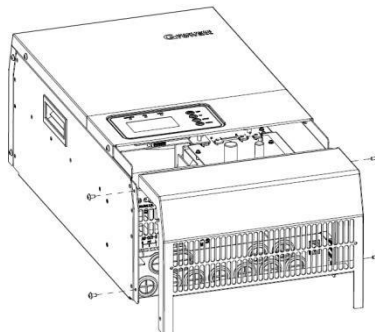

Mounting the Unit

Consider the following points before selecting where to install:

- ▶ Do not mount the inverter on flammable construction materials.
- ▶ Mount on a solid surface
- ▶ Install this inverter at eye level in order to allow the LCD display to be read at all times.
- ▶ The ambient temperature should be between 0°C and 50°C to ensure optimal operation.
- ▶ The recommended installation position is to be adhered to the wall vertically.
- ▶ Be sure to keep other objects and surfaces as shown in the right diagram to guarantee sufficient heat dissipation and to have enough space for removing wires.

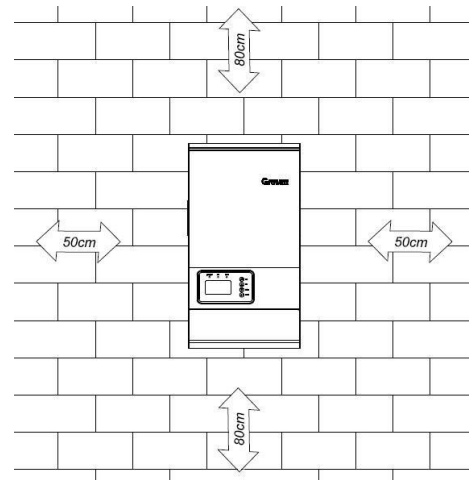

SUITABLE FOR MOUNTING ON CONCRETE OR OTHER NON-COMBUSTIBLE SURFACE ONLY.

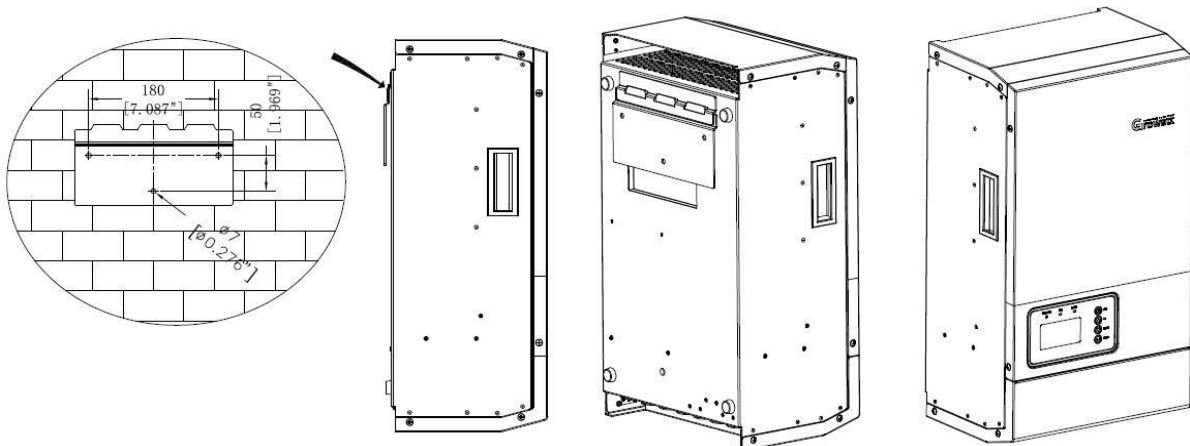

Screw three screws to install the unit. It is recommended to use attachment screw ST6.3X40 outside hexagon self-tapping stainless steel screws and Plastic expansion tube

Battery Connection

Lead-acid Battery Connection

User can choose proper capacity lead acid battery with a nominal voltage at 48V. Also, you need to choose battery type as "AGM(default) or FLD"

CAUTION: For safety operation and regulation compliance, it's requested to install a separate DC over-current protector or disconnect device between battery and inverter. It may not be requested to have a disconnect device in some applications, however, it's still requested to have over-current protection installed. Please refer to typical amperage in below table as required fuse or breaker size.

WARNING! All wiring must be performed by a qualified person.

WARNING! It's very important for system safety and efficient operation to use appropriate cable for battery connection. To reduce risk of injury, please use the proper recommended cable and terminal size as below.

Ring terminal:

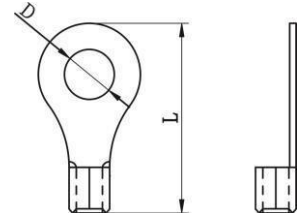

Recommended battery cable and terminal size:

Model	Wire Size	Torque value
SPF 3000T HVM-G2	1 * 4 AWG	2-3 Nm

Note: For lead acid battery, the recommended charge current is 0.2C(Cbattery capacity)

Please follow below steps to implement battery connection:

1. Assemble battery ring terminal based on recommended battery cable and terminal size.
2. Connect all battery packs as units requires. It's suggested to connect at least 200Ah capacity battery for SPF 3000T HVM-G2.
3. Insert the ring terminal of battery cable flatly into battery connector of inverter and make sure the bolts are tightened with torque of 2Nm. Make sure polarity at both the battery and the inverter/charge is correctly connected and ring terminals are tightly screwed to the battery terminals.

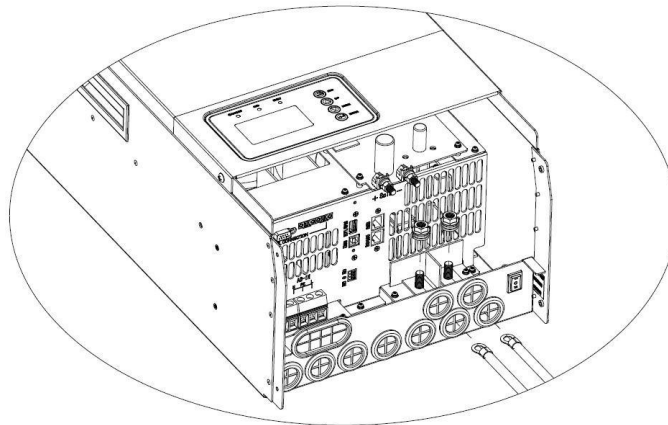

WARNING: Shock Hazard

Installation must be performed with care due to high battery voltage in series.



CAUTION!! Do not place anything between the flat part of the inverter terminal and the ring terminal. Otherwise, overheating may occur.

CAUTION!! Do not apply anti-oxidant substance on the terminals before terminals are connected tightly.

CAUTION!! Before making the final DC connection or closing DC breaker/disconnector, be sure positive (+) must be connected to positive (+) and negative (-) must be connected to negative (-).

Lithium Battery Connection

If choosing lithium battery for the inverter, you are allowed to use the lithium battery only which we have configured. There're two connectors on the lithium battery, RJ45 port of BMS and power cable.

Please follow below steps to implement lithium battery connection:

1. Assemble battery ring terminal based on recommended battery cable and terminal size (same as Lead acid, see section Lead-acid Battery connection for details) .
2. Insert the ring terminal of battery cable flatly into battery connector of inverter and make sure the bolts are tightened with torque of 2-3Nm. Make sure polarity at both the battery and the inverter/charge is correctly connected and ring terminals are tightly screwed to the battery terminals.
3. Connect the end of RJ45 of battery to BMS communication port(RS485 or CAN) of inverter.

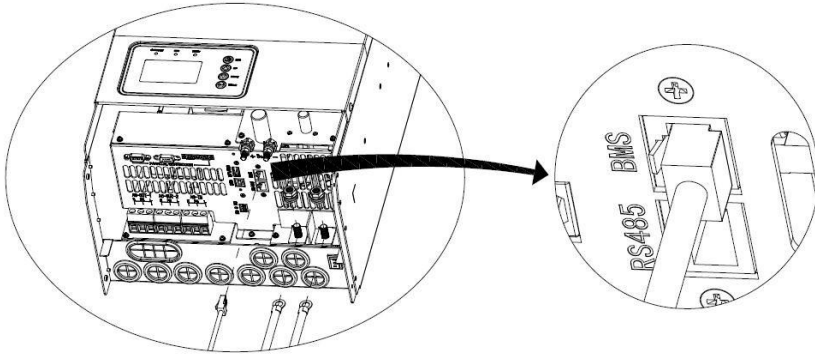

4. The other end of RJ45 insert to battery communication port(RS485 or CAN).

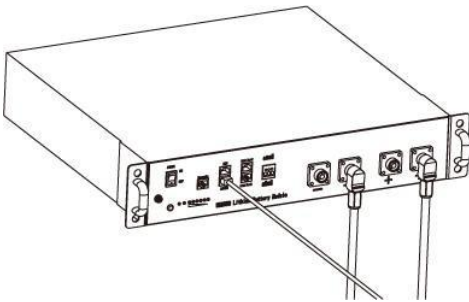

Note: If choosing lithium battery, make sure to connect the BMS communication cable between the battery and the inverter. You need to choose battery type as "lithium battery".

Lithium battery communication and setting

In order to communicate with battery BMS, you should set the battery type to "LI" in Program 5. Then the LCD will switch to Program 51, which is to set the protocol type. There are several protocols in the inverter. Please get instruction from Growatt to choose which protocol to match the BMS.

1. Connect the end of RJ45 of battery to BMS communication port of inverter

Make sure the lithium battery BMS port connects to the inverter is Pin to Pin, the inverter BMS port pin assignment shown as below:

Pin number	RS485 port	BMS port
1	RS485B	RS485B
2	RS485A	RS485A
3	--	--
4	--	CANH
5	--	CANL
6	--	--
7	--	--
8	--	--

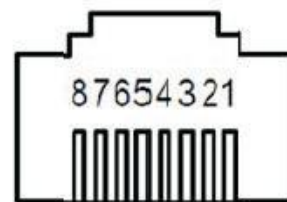

LCD setting

To connect battery BMS, need to set the battery type as "LI" in Program 05.



After set "LI" in Program 05, it will switch to Program 51 to choose communication protocol. You can choose RS485 communication protocol which is from L01 to L50, and you can also choose CAN communication protocol which is from L51 to L99.

Note: You can only use one communication type RS485 or CAN in a time.

05	Battery type	AGM (default)	bAtt AGM 005°
		Flooded	bAtt FLd 005°
		Lithium (only suitable when communicated with BMS)	bAtt LI 005°
		User-Defined	bAtt USE 005°
		User-Defined 2 (suitable when lithium battery without BMS communication)	bAtt US2 005°
		<p>If "User-Defined" is selected, battery charge voltage and low DC cut-off voltage can be set up in program 19, 20 and 21.</p>	
		<p>If "User-Defined 2" is selected, battery charge voltage and low DC cut-off voltage can be set up in program 19, 20 and 21. It is recommended to set to the same voltage in program 19 and 20(full charging voltage point of lithium battery). The inverter will stop charging when the battery voltage reaches this setting.</p>	

51	RS485 Communication protocol	Protocol L01	L01 S1°
		Protocol L02	L02 S1°
		.	.
		.	.
	CAN Communication protocol	Protocol L50	L50 S1°
		Protocol L51	L51 S1°
		Protocol L52	L52 S1°
		.	.
		Protocol L99	L99 S1°

Note: When the battery type set to Li, the setting option 12, 13, 21 will change to display percent.
Note: When the battery type set as "LI", the Maximum charge current can't be modified by the user. When the communication fail, the inverter will cut off output.

12	Setting SOC point back to utility source when selecting "SBU priority" or "Solar first" in program 01	 Default 40%, 6%~50% Settable, value set higher than Program 21 setting
13	Setting SOC point back to battery mode when selecting "SBU priority" or "Solar first" in program 01	 Default 80%, 60%~100% Settable
21	Low DC cut-off SOC If "LI" is selected in program 5, this program can be set up	 Default 20%, 5%~49% Settable, value set lower than Program 12 setting

Note: Any questions about communicating with BMS, please consult with Growatt.

AC Input/Output Connection

CAUTION!! Before connecting to AC input power source, please install a **separate** AC breaker between inverter and AC input power source. This will ensure the inverter can be securely disconnected during maintenance and fully protected from over current of AC input. The recommended spec of AC breaker is 32A for SPF 3000T HVM-G2.

CAUTION!! There are two terminal blocks with "IN" and "OUT" markings. Please do NOT mis-connect input and output connectors.

WARNING! All wiring must be performed by a qualified personnel.

WARNING! It's very important for system safety and efficient operation to use appropriate cable for AC input connection. To reduce risk of injury, please use the proper recommended cable size as below.

Suggested cable requirement for AC wires

Model	Gauge	Torque Value
SPF 3000T HVM-G2	1 * 10 AWG	1.2-1.6 Nm

Please follow below steps to implement AC input/output connection:

1. Before making AC input/output connection, be sure to open DC protector or disconnect first.
2. Cut the insulation sleeves of the six conductors by 10mm..
3. Insert AC input wires according to polarities indicated on terminal block and tighten the terminal screws. Be sure to connect PE protective conductor  first.

PE→Ground (yellow-green)

L→LINE (brown or black)

N→Neutral (blu

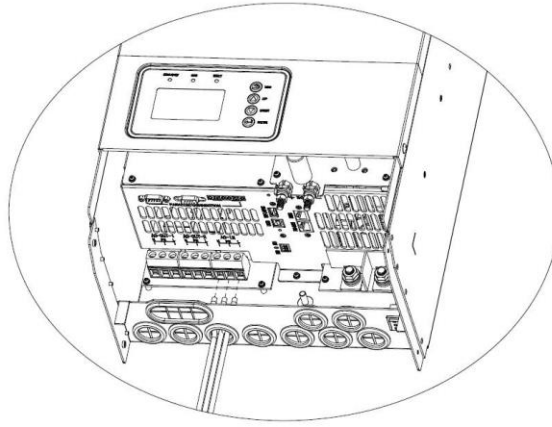

WARNING:

Be sure that AC power source is disconnected before attempting to hardwire it to the unit.

- Then, insert AC output wires according to polarities indicated on terminal block and tighten terminal screws. Be sure to connect PE protective conductor  first.

PE→Ground (yellow-green)

L→LINE (brown or black)

N→Neutral (blue)

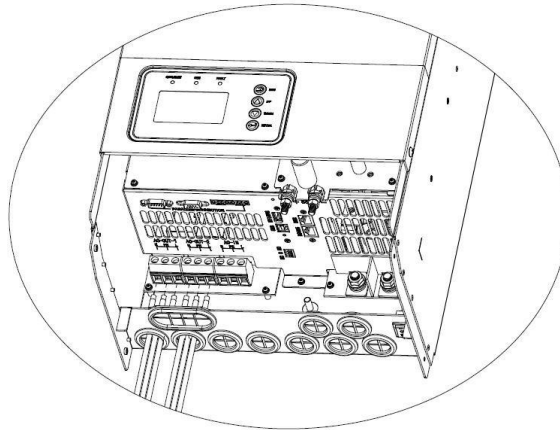

- Make sure the wires are securely connected.

CAUTION: Important

Be sure to connect AC wires with correct polarity. If L and N wires are connected reversely, it may cause utility short-circuited when these inverters are worked in parallel operation.

CAUTION: Appliances such as air conditioner are required at least 2~3 minutes to restart because it's required to have enough time to balance refrigerant gas inside of circuits. If a power shortage occurs and recovers in a short time, it will cause damage to your connected appliances. To prevent this kind of damage, please check with manufacturer of air conditioner that if it's equipped with time-delay function before installation. Otherwise, this off grid solar inverter will trig overload fault and cut off output to protect your appliance but sometimes it still causes internal damage to the air conditioner.

Note: Max. AC input current is 30A. If AC input current is over 30A, AC charge current will drop down to zero. Then the system will cut off output in 10 seconds if the AC input is continued to be over 30A.

Note:

'AC-OUT-1' will be as the main output line.

'AC-OUT-2' is intended for non-critical loads.

Under utility grid mode: AC-OUT-2 will always be available.

Under battery model: If overload happens, AC-OUT-2 will get cut off, only restart or system goes bypass would make AC-OUT-2 available again. If battery under voltage happens, AC-OUT-2 will get cut off and it would be available again when battery is back to normal.

PV Connection

CAUTION: Before connecting to PV modules, please install separately a DC circuit breaker between inverter and PV modules.

WARNING! All wiring must be performed by a qualified personnel.

WARNING! It's very important for system safety and efficient operation to use appropriate cable for PV module connection. To reduce risk of injury, please use the proper recommended cable size as below.

Model	Wire Size	Torque value
SPF 3000T HVM-G2	1 * 8AWG	1.2-1.6 Nm

PV Module Selection:

When selecting proper PV modules, please be sure to consider below parameters:

1. Open circuit Voltage (Voc) of PV modules not exceeds max. PV array open circuit voltage of inverter.
2. Open circuit Voltage (Voc) of PV modules should be higher than min. battery voltage.

INVERTER MODEL	SPF 3000T HVM-G2
Max. PV Array Open Circuit Voltage	250Vdc

Please follow below steps to implement PV module connection:

1. Remove insulation sleeve 10 mm for positive and negative conductors.

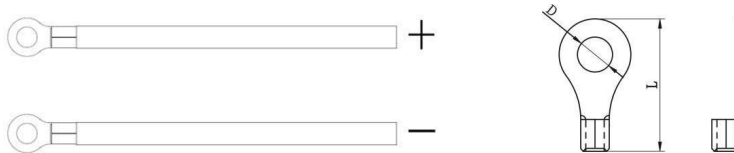

Check correct polarity of connection cable from PV modules and PV input connectors. Then, connect positive pole (+) of connection cable to positive pole (+) of PV input connector. Connect negative pole (-) of connection cable to negative pole (-) of PV input connector.

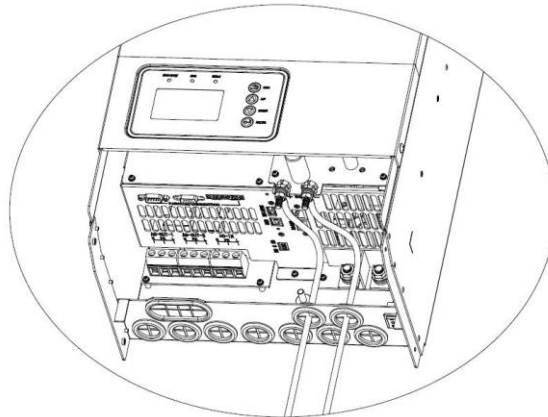

2. Make sure the wires are securely connected.

Final Assembly

After connecting all wiring, please put bottom cover back by screwing four screws as shown below.

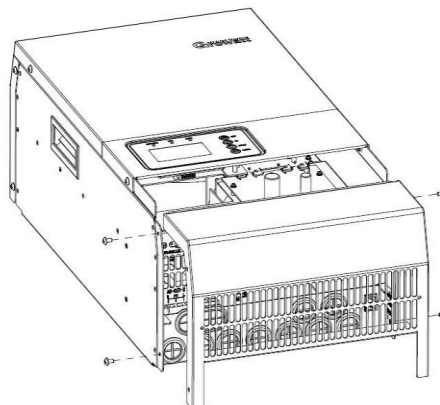

Communication Connection

Please use supplied communication cable to connect to inverter and PC. Insert bundled CD into a computer and follow on-screen instruction to install the monitoring software. For the detailed software operation, please check user manual of software inside of CD.

Dry Contact Signal

There is one dry contact(3A/250VAC) available on the rear panel. It could be used to deliver signal to external device when battery voltage reaches warning level.

Unit Status	Condition		Dry contact port:		
			NC & C	NO & C	
Power Off	Unit is off and no output is powered.		Close	Open	
Power On	Output is off and no output is powered		Close	Open	
	Output is powered from Battery or Solar	Battery not in "LI" mode	Battery voltage < Low DC Cut-off Voltage +2Vdc	Open	Close
			Detected there's AC input	Close	Open
	Output is powered from Battery or Solar	Battery in "LI" mode	Battery SOC < Low DC Cut-off Soc +5%	Open	Close
Detected there's AC input			Close	Open	

Battery Charger

The inverter is equipped with an active PFC (power factor correction) multistage battery charger.

When AC voltage is in the range of 154~260VAC, the charging current is 100%. The inverter is with a strong charging current, and the charge current can be adjusted from 10A~40A.

There are mainly 3 stages:

Bulk Charging: This is the initial stage of charging. While Bulk Charging, the charger supplies the battery with controlled constant current. The charger will remain in Bulk charge until the absorption charge voltage is achieved.

Absorb Charging: This is the second charging stage and begins after the absorb voltage has been reached. Absorb charging provides the batteries with a constant voltage and reduces the DC charging current in order to maintain the absorb voltage setting.

In this period, the inverter will start a T1 time; the charger will keep the boost voltage in Boost CV mode until the T1 time has run out. When charging current is $<0.01C$ or the time is over 12 hours, then drop the voltage Down to the float voltage.

Float Charging: The third charging stage occurs at the end of the absorb charging time. During float charging, the charge voltage is reduced to the float charge voltage. In this stage, the battery are kept fully charged and ready if needed by the inverter.

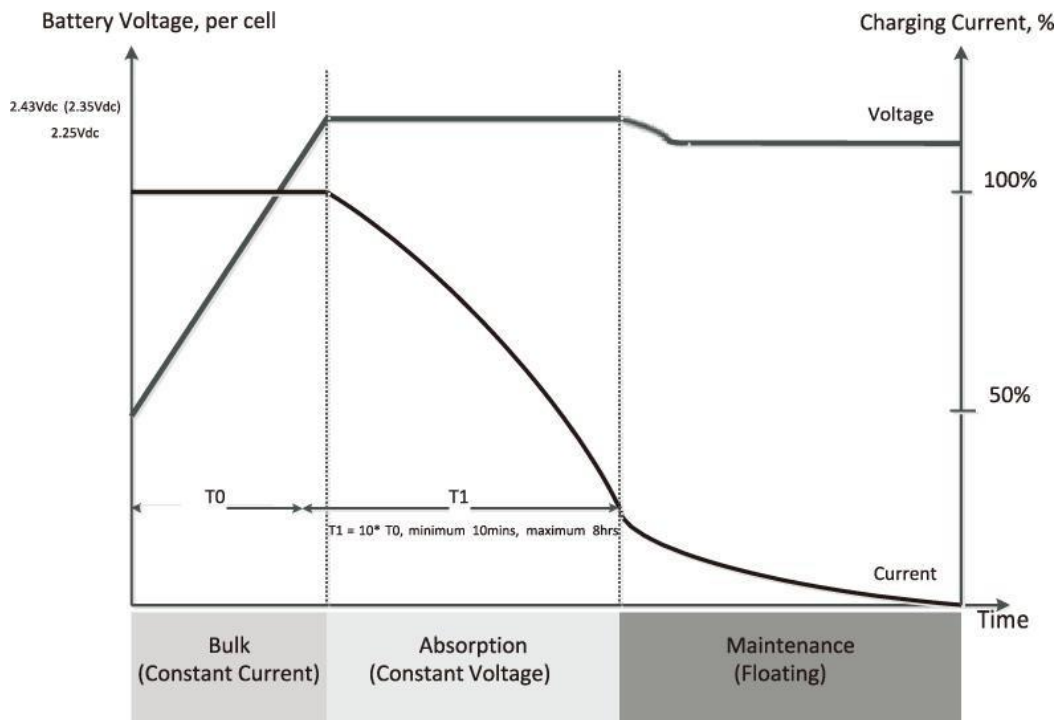

Battery Equalization

Equalization function is added into charge controller. It reverses the buildup of negative chemical effects like stratification, a condition where acid concentration is greater at the bottom of the battery than at the top. Equalization also helps to remove sulfate crystals that might have built up on the plates. If left unchecked, this condition, called sulfation, will reduce the overall capacity of the battery. Therefore, it's recommended to equalize battery periodically.

How to Apply Equalization Function

You must enable battery equalization function in monitoring LCD setting program 27 first. Then, you may apply this function in device by either one of following methods:

1. Setting equalization interval in program 31.
2. Active equalization immediately in program 32.

When to Equalize

In float stage, when the setting equalization interval (battery equalization cycle) is arrived, or equalization is active immediately, the controller will start to enter Equalize stage.

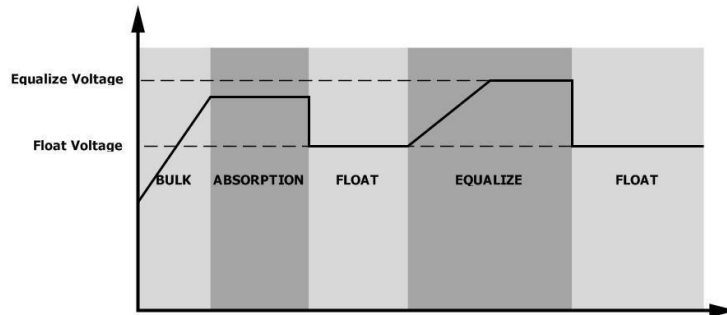

Equalize charging time and timeout

In Equalize stage, the controller will supply power to charge battery as much as possible until battery voltage raises to battery equalization voltage. Then, constant-voltage regulation is applied to maintain battery voltage at the battery equalization voltage. The battery will remain in the Equalize stage until setting battery equalized time is arrived.

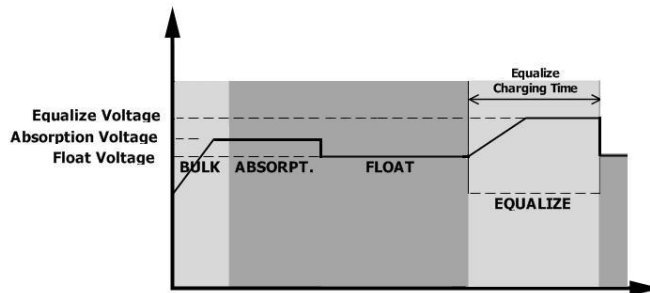

However, in Equalize stage, when battery equalized time is expired and battery voltage doesn't rise to battery equalization voltage point, the charge controller will extend the battery equalized time until battery voltage achieves battery equalization voltage. If battery voltage is still lower than battery equalization voltage when battery equalized timeout setting is over, the charge controller will stop equalization and return to float stage.

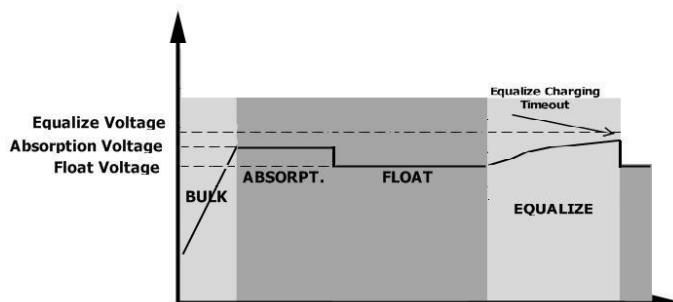

Operation

Power ON/OFF

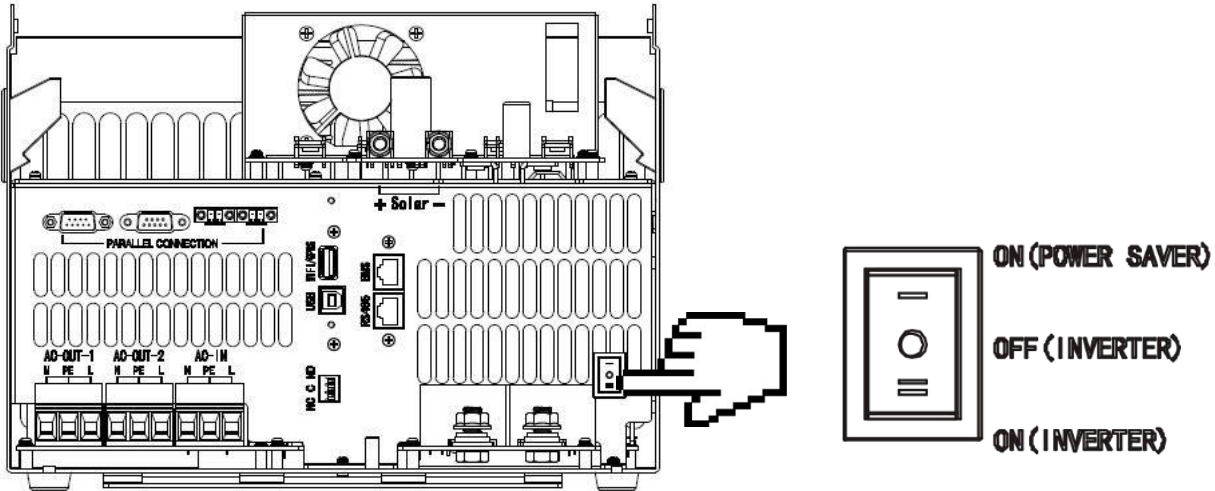

Once the unit has been properly installed and the batteries are connected well, simply press On/Off switch (located on the button of the case) to turn on the unit. The switch is located on the underside to the bottom right of the product.

The switch has three positions. The middle position means OFF. The II position means ON, turning on inverting and inverter is fully functional. The I position is Power Save Mode, inverter will only go inverting when loads are higher than 50W if under this power save mode.

Operation and Display Panel

The operation and display panel, shown in below chart, is on the front panel of the inverter. It includes three indicators, four function keys and a LCD display, indicating the operating status and input/output power information.

1. LCD display
2. Status indicator
3. Charging indicator
4. Fault indicator
5. Function buttons

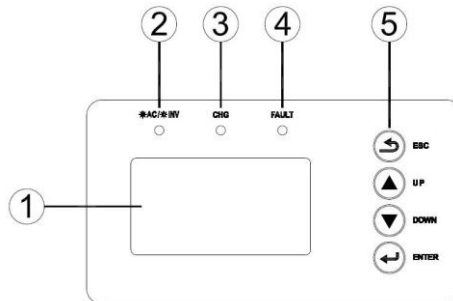

LED Indicator

LED Indicator		Messages	
☀️ AC / ☀️ INV	Green	Solid On	Output is powered by utility in Line mode.
		Flashing	Output is powered by battery or PV in battery mode.
☀️ CHG	Green	Solid On	Battery is fully charged.
		Flashing	Battery is charging.
⚠️ FAULT	Red	Solid On	Fault occurs in the inverter.
		Flashing	Warning condition occurs in the inverter.

Function Buttons

Button	Description
ESC	To exit setting mode
UP	To go to previous selection
DOWN	To go to next selection





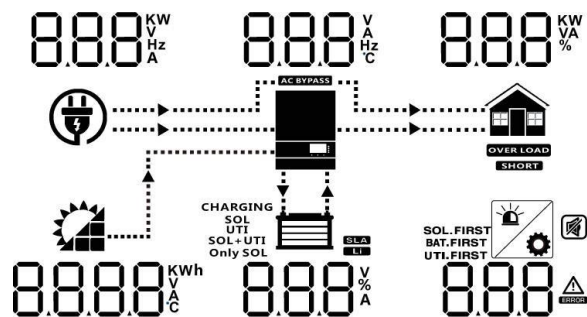







ENTER	To confirm the selection in setting mode or enter setting mode
-------	--

LCD Display Icons





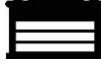



Icon	Description
AC Input Information	
	AC input icon
	Indicate AC input power, AC input voltage, AC input frequency, AC input current
	Indicate AC power loads in bypass
PV Input Information	
	PV input icon
	Indicate PV power, PV voltage, PV current
Output Information	
	Inverter icon
	Indicate output voltage, output current, output frequency, inverter temperature
Load Information	
	Load icon
	Indicate power of load, power percentage of load
	Indicate overload happened
	Indicate short circuit happened
Battery Information	
	Indicate battery level by 0-24%, 25-49%, 50-74% and 75-100% in battery mode and charging status in line mode.
	Indicate battery voltage, battery percentage, battery current
	Indicate SLA battery
	Indicate lithium battery
	Indicate charging source priority: solar first, solar and utility, or only solar
Other Information	
	Indicate output source priority: solar first, utility first, SBU mode or SUB mode
	Indicate warning code or fault code
	Indicate a warning or a fault is happening
	Indicate it's during setting values
	Indicate the alarm is disabled

In AC mode, battery icon will present Battery Charging Status		
Status	Battery voltage	LCD Display
Constant Current mode / Constant Voltage mode	<2V/cell	4 bars will flash in turns.
	2 ~ 2.083V/cell	Bottom bar will be on and the other three bars will flash in turns.
	2.083 ~ 2.167V/cell	Bottom two bars will be on and the other two bars will flash in turns.
	> 2.167 V/cell	Bottom three bars will be on and the top bar will flash.
Floating mode. Batteries are fully charged.		4 bars will be on.

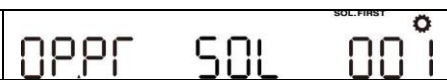
In battery mode, battery icon will present Battery Capacity		
Load Percentage	Battery Voltage	LCD Display
Load >50%	< 1.717V/cell	
	1.717V/cell ~ 1.8V/cell	
	1.8 ~ 1.883V/cell	
	> 1.883 V/cell	
50% > Load > 20%	< 1.817V/cell	
	1.817V/cell ~ 1.9V/cell	
	1.9 ~ 1.983V/cell	
	> 1.983	
Load < 20%	< 1.867V/cell	
	1.867V/cell ~ 1.95V/cell	
	1.95 ~ 2.033V/cell	
	> 2.033	

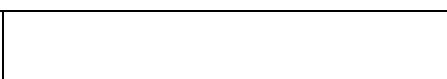









LCD Setting

After pressing and holding ENTER button for 3 seconds, the unit will enter setting mode. Press "UP" or "DOWN" button to select setting programs. Then press "ENTER" button to confirm the selection or ESC button to exit.

Program	Description	Setting Option
01	Output source priority: To configure load power source priority	Solar first 
		Solar energy provides power to the loads as first priority. If solar energy is not sufficient to power all connected loads, battery energy will supply power the loads at the same time. Utility provides power to the loads only when any one condition happens: - Solar energy is not available - Battery voltage drops to either low-level warning voltage or the setting point in program 12.
		Utility first (default) 
		Utility will provide power to the loads as first priority. Solar and battery energy will provide power to the loads only when utility power is not available.
		SBU priority 
		Solar energy provides power to the loads as first priority. If solar energy is not sufficient to power all connected loads, battery energy will supply power to the loads at the same time. Utility provides power to the loads only when battery voltage drops to either low-level warning voltage or the setting point in program 12.
02	Maximum charging current: set total charging current for solar and utility chargers. (Max. charging current = utility charging current + solar charging current)	
		Default 80A, 10A~120A Settable (If LI is selected in Program 5, this program can't be set up)
03	AC input voltage range	Appliance (default) 
		If selected, acceptable AC input voltage range will be within 154~272VAC UPS 

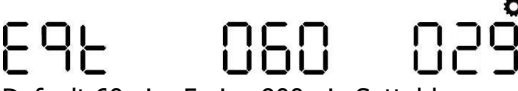
05	Battery type	AGM (default)	
		bAtt AGM 005 ^o	
		Flooded	
		bAtt FLd 005 ^o	
		Lithium (only suitable when communicated with BMS)	
bAtt LI 005 ^o			
User-Defined		bAtt USE 005 ^o	
If "User-Defined" is selected, battery charge voltage and low DC cut-off voltage can be set up in program 19, 20 and 21.			
User-Defined 2 (suitable when lithium battery without BMS communication)		bAtt US2 005 ^o	
If "User-Defined 2" is selected, battery charge voltage and low DC cut-off voltage can be set up in program 19, 20 and 21. It is recommended to set to the same voltage in program 19 and 20(full charging voltage point of lithium battery). The inverter will stop charging when the battery voltage reaches this setting.			
06	Auto restart when overload occurs	Restart disable (default)	
		LdRS dIS 006 ^o	
		Restart enable	
LdRS ENR 006 ^o			
Restart bypass		LdRS bYP 006 ^o	
When overload under battery mode, system will switch to bypass automatically			
08	Output voltage	230V (default)	220V
		OUTV 230 008 ^o	OUTV 220 008 ^o
		240V	208V
		OUTV 240 008 ^o	OUTV 208 008 ^o
09	Output frequency	50Hz (default)	60Hz
		OUTF 50 009 ^o	OUTF 60 009 ^o
11	Maximum utility charging current Note: If setting value in Program 02 is smaller than that in Program 11, the inverter will apply charging current from Program 02 for utility charger	ACI 30 ^A 011 ^o Default 30A, 0A~40A Settable (If LI is selected in Program 5, this program can't be set up)	

12	Setting voltage point back to utility source when selecting "SBU priority" or "Solar first" in program 01	b2AC 46.0 ^v 0 12 ^{⚙️} Default 46.0V, 44.0V~51.2V Settable	
		b2AC 40% 0 12 ^{⚙️} Default 40%, 6%~50% Settable, value set higher than Program 21 setting	
13	Setting voltage point back to battery mode when selecting "SBU priority" or "Solar first" in program 01	AC26 54.0 ^v 0 13 ^{⚙️} Default 54.0V, 48.0V~58.0V Settable	
		AC26 80% 0 13 ^{⚙️} Lithium battery mode: default 80%, 60%~100% settable	
14	Charger source priority: To configure charger source priority	If this off grid solar inverter is working in Line, Standby or Fault mode, charger source can be programmed as below:	
		Utility first CG.PF ^{UTI} CUE 0 14 ^{⚙️}	Utility will charge battery as first priority. Solar energy will charge battery only when utility power is not available.
		Solar first CG.PF ^{SOL} CSO 0 14 ^{⚙️}	Solar energy will charge battery as first priority. Utility will charge battery only when solar energy is not available.
		Solar and Utility CG.PF ^{SOL+UTI} SNU 0 14 ^{⚙️}	Solar energy and utility will both charge battery.
		Only Solar CG.PF ^{Only SOL} OSO 0 14 ^{⚙️}	Solar energy will be the only charger source no matter utility is available or not.
		If this off grid solar inverter is working in Battery mode or Power saving mode, only solar energy can charge battery. Solar energy will charge battery if it's available and sufficient.	
15	Alarm control	Alarm on (default) BUZZ ON 0 15 ^{⚙️}	Alarm off BUZZ OFF 0 15 ^{⚙️}
16	Backlight control	Backlight on (default) LCdb ON 0 16 ^{⚙️}	Backlight off LCdb OFF 0 16 ^{⚙️}
17	Beeps while primary source is interrupted	Alarm on (default) ALAR ON 0 17 ^{⚙️}	Alarm off ALAR OFF 0 17 ^{⚙️}
19	C.V. charging voltage. If self-defined is selected In program 5, this program can be set up	CV 56.4 ^v 0 19 ^{⚙️} Default 56.4V, 48.0V~58.4V Settable	
20	Floating charging voltage. If self-defined is selected in program 5, this program can be set up	FLEV 54.0 ^v 0 20 ^{⚙️} Default 54.0V, 48.0V~58.4V Settable	

21	Low DC cut-off voltage. If self-defined is selected in program 5, this program can be set up.	 Default 42.0V, 40.0V~48.0V Settable	
		 Default 20%, 5%~49% Settable, value set lower than Program 12 setting	
		When reach Low DC cut-off voltage: If battery power is only power source available, inverter will shut down. If PV energy and battery power are available, inverter will charge battery without AC output. If PV energy, battery power and utility are all available, inverter will transfer to line mode and provide output power to loads, and charge the battery at the same time.	
22	RS485 communication address	 Default 001,001-255 Settable	
27	Battery equalization	 Battery equalization enable	 Battery equalization disable(default)
		If "Flooded" or "User-Defined" is selected in program 05, this program can be set up.	
28	Battery equalization voltage	 Default 58.4V, 48.0V~60V Settable (the value should be higher than Program 19 value)	
29	Battery equalized time	 Default 60min, 5min~900min Settable	
30	Battery equalized timeout	 Default 120min, 5min~900min Settable	
31	Equalization interval	 Default 1days, 1 days~90 days Settable	
32	Equalization activated immediately	Equalization activated immediately enable	Equalization activated immediately disable (default)
		 	
		If equalization function is enabled in program 27, this program can be setup. If "On" is selected in this program, it's to activate battery equalization immediately and LCD main page will shows "EQ". If "Off" is selected, it will cancel equalization function until next activated equalization time arrives based on program 31setting. At this time, "EQ" will not be shown in LCD main page.	

Display Information

The LCD display information will be switched in turns by pressing "UP" or "DOWN" key. The selectable information is switched as below order: voltage, frequency, current, power, firmware version.

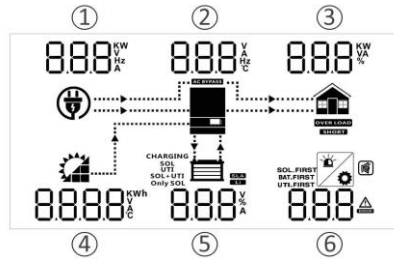

Setting Information	LCD display
① AC Input voltage ② Output voltage ③ Load percentage ④ PV input voltage ⑤ Battery voltage ⑥ Warning or Fault code (Default Display Screen)	
① AC Input frequency ② Output frequency ③ Load power in VA ④ PV energy sum in KWH ⑤ Battery percentage ⑥ Warning or Fault code	
① AC Input current ② Output current ③ Load percentage ④ PV input current ⑤ Battery charging current ⑥ Warning or Fault code	
① AC input power in Watts ② Inverter temperature ③ Load power in Watts ④ PV energy sum in KWH ⑤ Battery percentage ⑥ Warning or Fault code	
Firmware version (CPU1: 040-00-b21; CPU2:041-00-b21)	
Time (15:20:10, December 15, 2018)	

Operating Mode Description

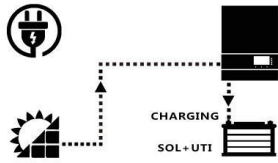
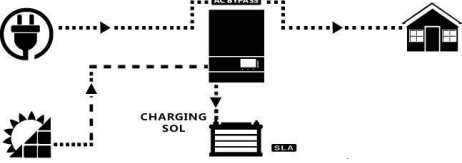
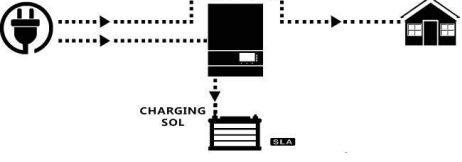
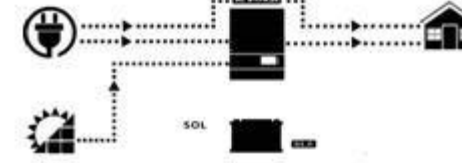
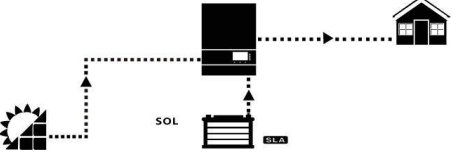
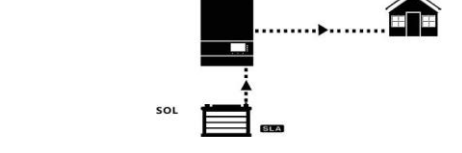
Operation mode	Description	LCD display
<p>Standby mode</p> <p>Note: *Standby mode: The inverter is not turned on yet but at this time, the inverter can charge battery without AC output.</p>	<p>No output is supplied by the unit but PV it still can charge batteries.</p>	<p>When utility grid connected, no charging; PV can charge</p> 
<p>Line Mode</p>	<p>The unit will provide output power from the mains. It can also charge the battery at line mode.</p>	<p>Charging by PV energy</p> 
		<p>Charging by utility</p> 
		<p>No battery connected</p> 
<p>Battery Mode</p>	<p>The unit will provide output power from battery and PV power.</p>	<p>Power from battery and PV energy</p> 
		<p>Power from battery only</p> 

Fault Code

Fault Code	Fault Event	Icon on
01	Inverter Fan is not working	01 _{ERROR}
02	Inverter Over temperature	02 _{ERROR}
03	Battery voltage is too high	03 _{ERROR}
04	Battery voltage is too low	04 _{ERROR}
05	Output short circuited	05 _{ERROR}
06	Output voltage is abnormal. Output voltage is too high.	06 _{ERROR}
07	Overload time out	07 _{ERROR}
20	BMS communication error	20 _{ERROR}
51	Over current or surge	51 _{ERROR}

Warning Code

Warning Code	Warning Event	Audible Alarm	Icon flashing
01	PV Fan is not working	Beep once every second	01 [△]
02	PV Over temperature	Beep once every second	02 [△]
04	Low battery	Beep once every second	04 [△]
07	Overload	Beep once every second	07 [△]
13	Solar charger stops due to high PV voltage	Beep once every second	13 [△]
19	Battery disconnect	Beep once every second	19 [△]
51	PV Over current or surge	Beep once every second	51 [△]
58	AC output low voltage	Beep once every second	58 [△]
63	Sampling error of battery voltage detecting is over 0.5V	Beep once every second	63 [△]

Trouble Shooting

Problem	LCD/LED/Buzzer	Explanation / Possible cause	What to do
Unit shuts down automatically during startup process.	LCD/LEDs and buzzer will be active for 3 seconds and then complete off.	The battery voltage is too low (<1.91V/Cell)	1. Re-charge battery. 2. Replace battery.
No response after power on.	No indication.	1. The battery voltage is far too low. (<1.4V/Cell) 2. Battery polarity is connected reversed.	1. Check if batteries and the wiring are connected well. 2. Re-charge battery. 3. Replace battery.
Buzzer beeps continuously and red LED is on.	Fault code 01	Fan fault	Replace the fan.
	Fault code 02	Internal temperature of component is over 90°C.	Check if the air flow of the unit is blocked or the ambient temperature is too high.
	Fault code 03	Battery is over-charged.	Return to repair center.
		The battery voltage is too high.	Check if spec and quantity of batteries are meet requirements.
	Fault code 04	The battery voltage is too low.	
	Fault code 05	Output short circuited.	Check if wiring is connected well and remove abnormal load.
	Fault code 06/58	Output abnormal (Inverter voltage below than 180Vac or is higher than 290Vac)	1. Reduce the connected load. 2. Return to repair center
	Fault code 07	Overload error. The inverter is overload 101% and time is up.	Reduce the connected load by switching off some equipment.
	Fault code 20	BMS communication failed	1. Check the BMS communication wire to see if it's well connected 2. Check the transceiver signal
Fault code 51	Over current or surge	Restart the unit, if the error happens again, please return to repair center.	

Note: To restart the inverter, all power sources need to be disconnected. After the LCD screen light is off, only use the battery to boot.

Specifications

Table 1 Line Mode Specifications

INVERTER MODEL	SPF 3000T HVM-G2
Input Voltage Waveform	Pure sine wave/ same as input (bypass mode)
Nominal Input Voltage	230Vac
Input voltage range	184~272Vac (UPS) ; 154~272Vac (APL)
Low Loss Voltage	184Vac±7V(UPS); 154Vac±7V(APL)
Low Loss Return Voltage	194Vac±7V(UPS); 164Vac±7V(APL)
High Loss Voltage	>272Vac±7V
High Loss Return Voltage	<262Vac±7V
Nominal Input Frequency	50Hz / 60Hz (Auto detection)
Input Frequency range	45-65Hz
Low Loss Frequency	45±1Hz
Low Loss Return Frequency	47±1Hz
High Loss Frequency	65 ± 1Hz
High Loss Return Frequency	63 ± 1Hz
Efficiency (Line Mode)	>95% (Rated R load, battery full charged)
Input Current	Max 30A
Transfer Time	Typical 10ms

Table 2 Inverter Mode Specifications

INVERTER MODEL	SPF 3000T HVM-G2
Rated Output Power	3KVA / 3KW
Output Voltage Waveform	Pure Sine Wave
Output Voltage Regulation	230Vac±5%
Output Frequency	50Hz
Peak Efficiency	94%
Overload Protection	10s@101%~150% load; 5s@≥150% load
Surge Capacity	9KVA / 9KW
Nominal DC Input Voltage	48Vdc
Cold Start Voltage(Lead-Acid Mode)	Low DC Cut-Off Voltage +2Vdc
Cold Start SOC(Li Mode)	>Low DC Cut-off SOC +10%
Low DC Warning Voltage (Lead-Acid Mode)	44.0Vdc @ load < 20% 42.8Vdc @ 20% ≤ load < 50% 40.4Vdc @ load ≥ 50%
Low DC Warning Return Voltage (Lead-Acid Mode)	46.0Vdc @ load < 20% 44.8Vdc @ 20% ≤ load < 50% 42.4Vdc @ load ≥ 50%
Low DC Cut-off Voltage (Lead-Acid Mode)	42.0Vdc @ load < 20% 40.8Vdc @ 20% ≤ load < 50% 38.4Vdc @ load ≥ 50%
Low DC Cut-off Voltage (Lead-Acid Mode)	42.0Vdc (Based on Program 21, 40Vdc~48Vdc settable)
Low DC Warning SOC (Li Mode)	Low DC Cut-off SOC +5%
Low DC Warning Return SOC (Li Mode)	Low DC Cut-off SOC +15%
Low DC Cut-off SOC(Li Mode)	Default 20%, 5%~49% settable
High DC Recovery Voltage	58Vdc
High DC Cut-off Voltage	AGM:60V, FLD:62V, USE or Li Mode: C.V. Voltage + 4.0V
No Load Power Consumption	<20W

Table 3 Charge Mode Specifications

Utility Charging Mode		
INVERTER MODEL		SPF 3000T HVM-G2
Charging Algorithm		3-Step
Max. AC Charging Current		40Amp(@ $V_{IP}=230V_{ac}$)
Bulk Charging Voltage	Flooded Battery	58.4Vdc
	AGM / Gel Battery	56.4Vdc
Floating Charging Voltage		54Vdc
MPPT Solar Charging Mode		
Max. PV Array Power		4500W
Max. PV Array Open Circuit Voltage		250Vdc
Max. PV Charging Current		80A
Bulk Charging Voltage	Flooded Battery	58.4Vdc
	AGM / Gel Battery	56.4Vdc
Floating Charging Voltage		54Vdc

Table 4 General Specifications

INVERTER MODEL	SPF 3000T HVM-G2
Operating Temperature Range	-20°C to 50°C (fan assisted cooling)
Storage temperature	-40°C~ 60°C
Humidity	5% to 95% Relative Humidity (Non-condensing)
Altitude	<2000m
Dimension(D*W*H), mm	550 x 300 x 225
Net Weight, kg	27